



User Manual

Application Examples



Version of document: 2.01

Software
CBox: v3

Language: English

- I. Presentation
- II. Overview
- III. Digging a manhole
 - a) Method 1: Using the bottom of the manhole as the reference
 - b) Method 2: Using (e.g.) a surveyor's stake as the reference
- IV. Digging a 5m wide manhole
- V. Digging a manhole using a rotating laser
 - a) Method 1: Knowing the Laser Height
 - b) Method 2: Not knowing the Laser Height
- VI. Digging a trench with 2% slope
 - a) Method 1: Using the bottom of the trench as the reference
 - b) Method 2: Using (e.g.) a surveyor's stake as the reference
- VII. Digging a trench with 2% slope using a rotating laser
 - a) Method 1: Knowing the Laser Height
 - b) Method 2: Not knowing the Laser Height
- VIII. Changing the elevation
 - a) Method 1: Working without a rotating laser
 - b) Method 1: Working with a rotating laser
- IX. Moving the machine
- X. Notes



Presentation

Using this system on an excavator you may dig down to the desired depth with or without slope without the need of leaving the cab to control or a grade checker.

With this system, capable to measure in three dimensions, you may measure the distance between two points located anywhere, such as the dimension of a trench, and the inclination of existing slopes. All measurements are taken from the two ends left, right and centre of the bucket blade (or teeth tip) until a point of reference.

Sensors measure the angles of all moving parts (Chassis, booms, bucket) and the information is transmitted to the display in the cab. A step-stair LED display provides according informations.

A patented system enables to install and calibrate the system in less than an hour without specific required know-how of machine control. Wireless technology makes it portable on each machine in your fleet.



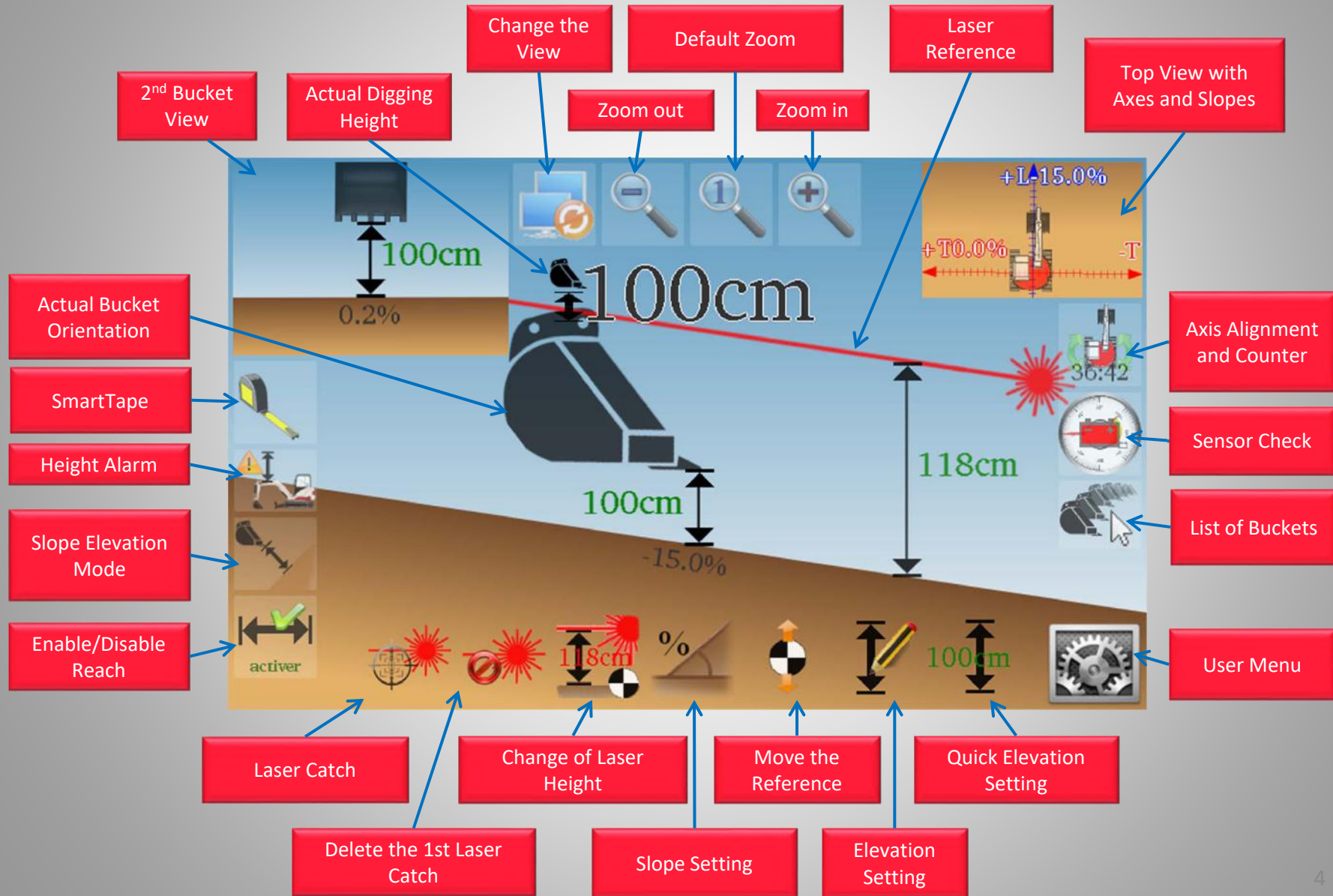



DIGGING A MANHOLE

Method 1: Using the bottom of the manhole as the reference

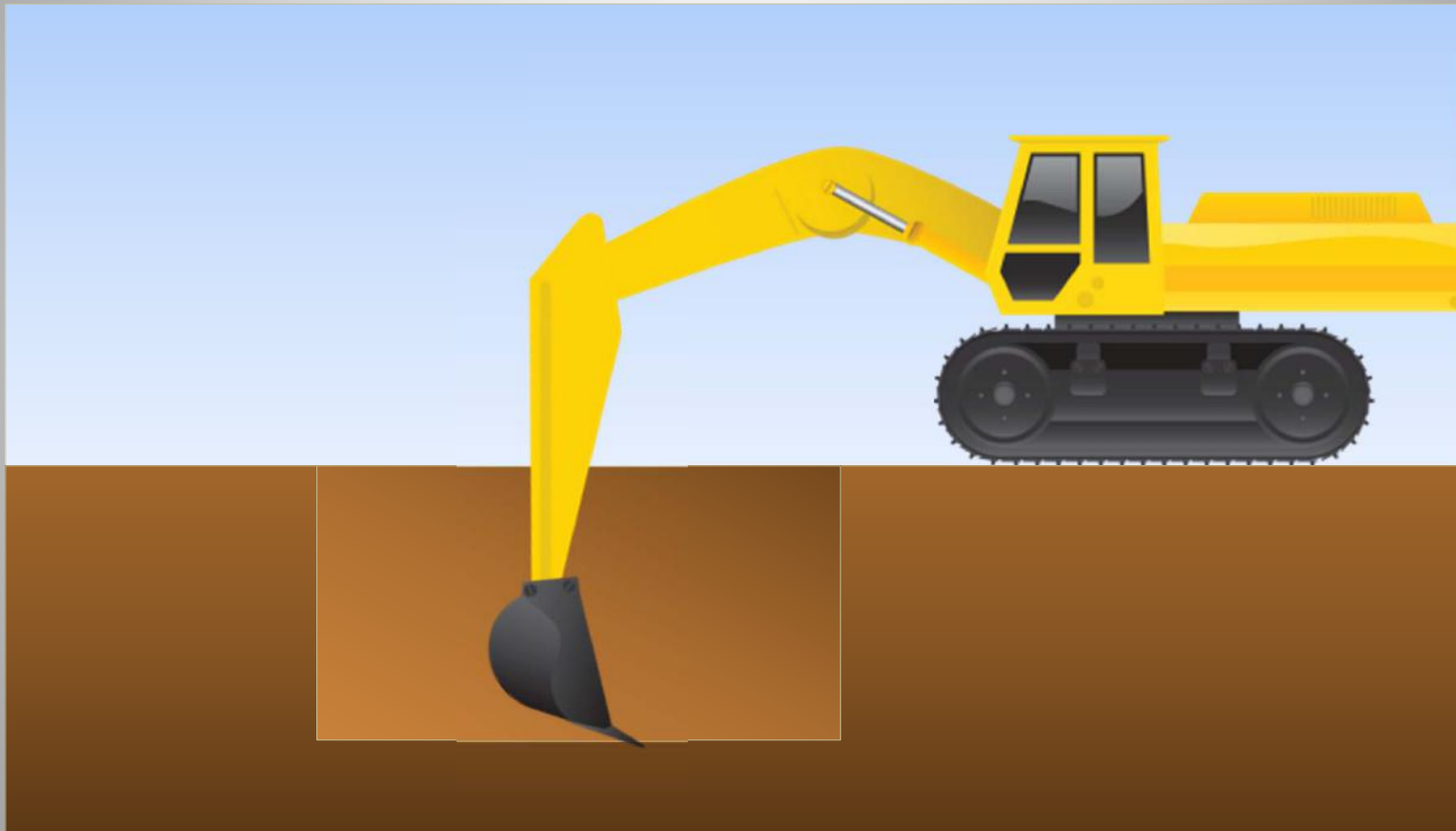

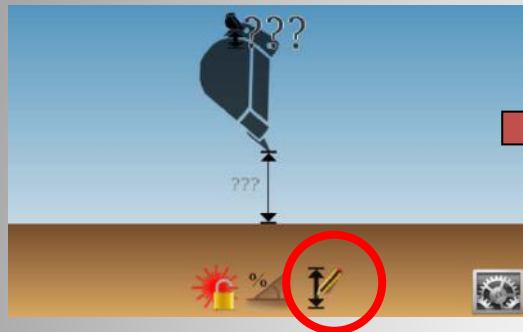

1. Place the tip of the bucket at the bottom of the trench and then press the symbol "Elevation"



2. Enter '0' as the height (you are at the bottom of the manhole) then validate.



→ The screen and the LED Display are now giving you real-time elevation informations.

Note: After the first setting of elevation, a second button appears on the very right hand side: by clicking on it, you'll set the last dialed-in elevation with one single click; here: 0,00m.



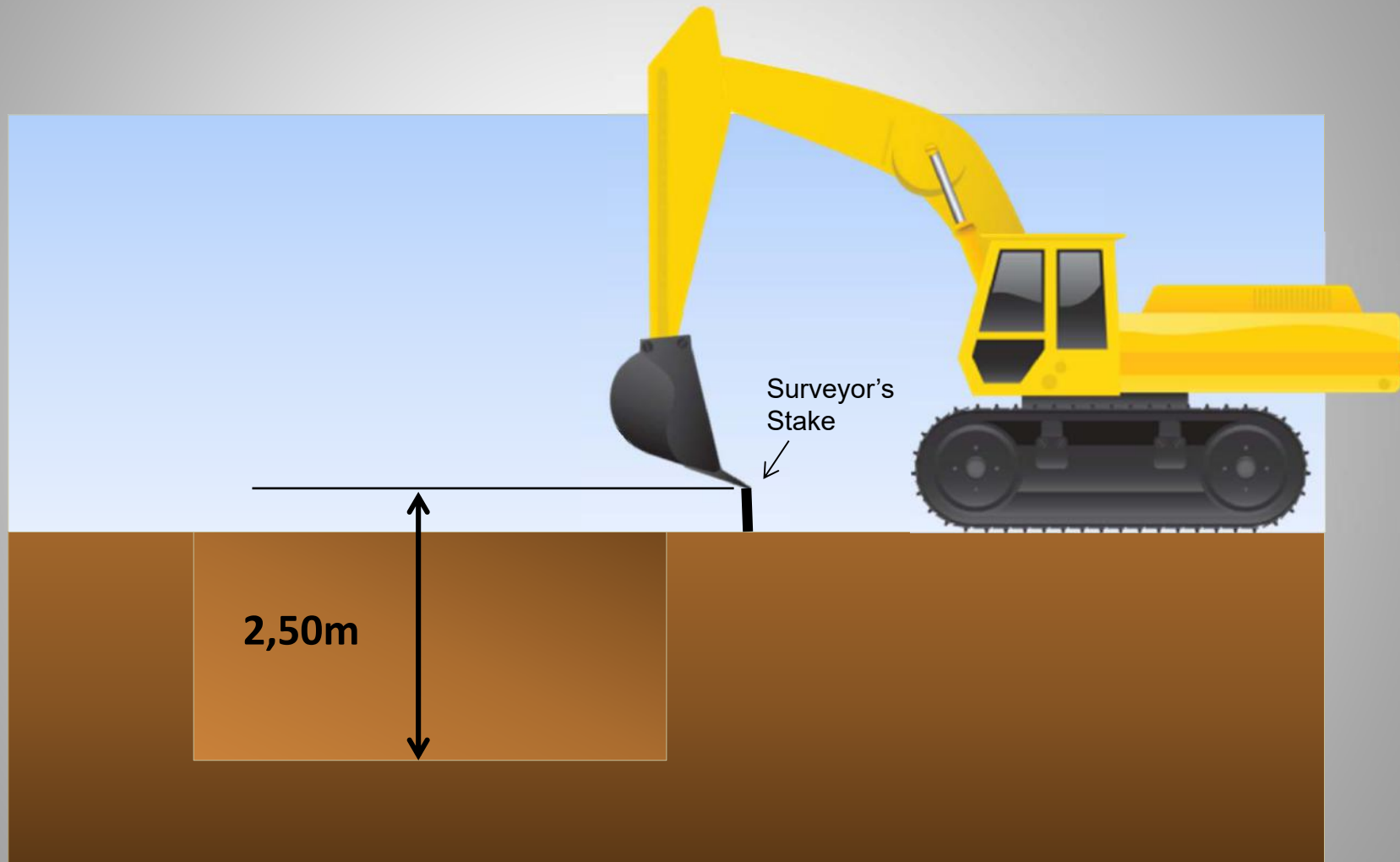

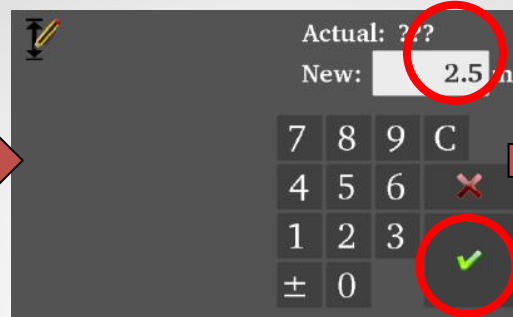
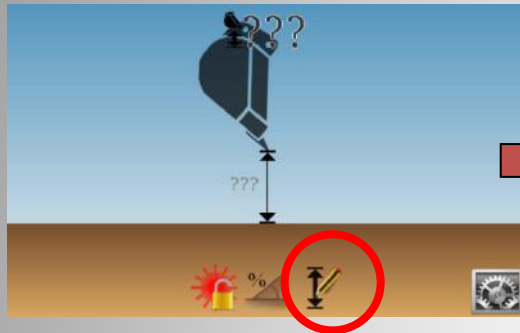

1. Place the tip of the bucket on the surveyor's stake and then press the symbol "Elevation"

2. Enter « 2,50m » as your actual elevation and validate.

→ The screen and the LED Display are now giving you real-time elevation informations.

Note: After the first setting of elevation, a second button appears on the very right hand side: by clicking on it, you'll set the last dialed-in elevation with one single click; here: 2,50m.





DIGGING A 5M WIDE MANHOLE

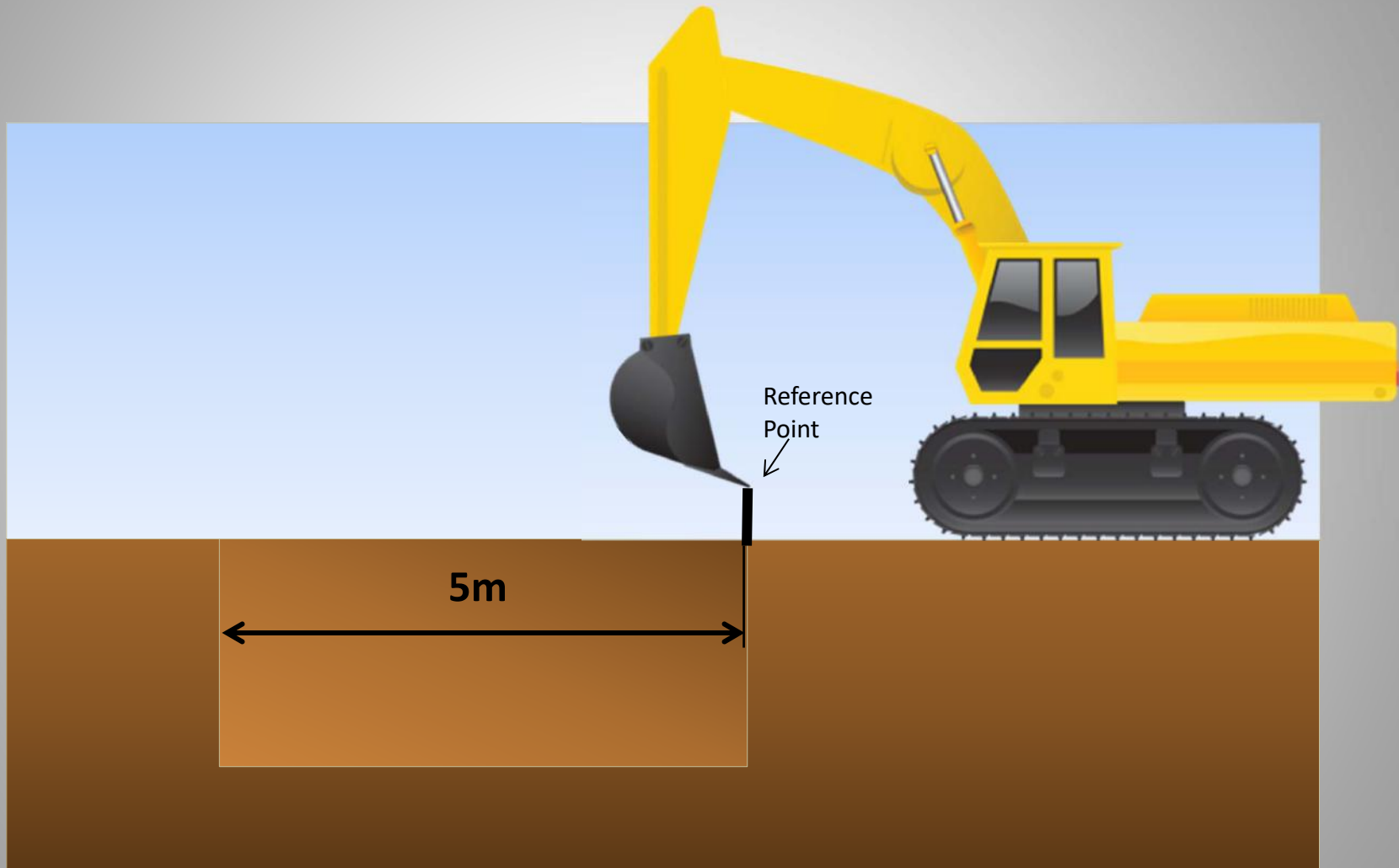

Note: These steps occur in addition to the examples described previously.

1. Click on the button "Enable/Disable Reach" on the left hand of the screen: _____



2. If a 2D sensor is available, align the cabin along the manhole, and then click the alignment button: _____



1. Place the tip of the bucket on the point of reference.

2. Click on the "Reach Setting" button: _____



3. Depending on the working conditions, there are now two possibilities:

Possibility 1:

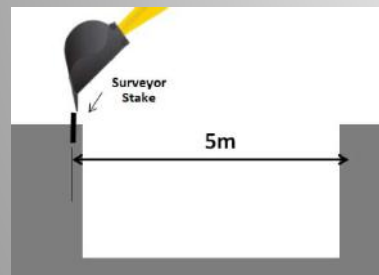

→ Dial-in **5m**

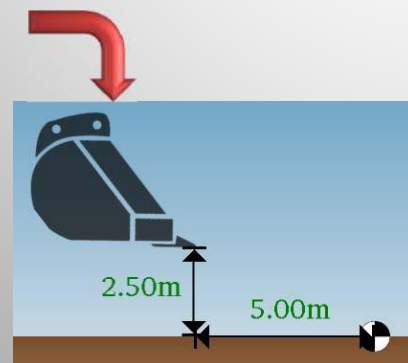

Possibility 2:

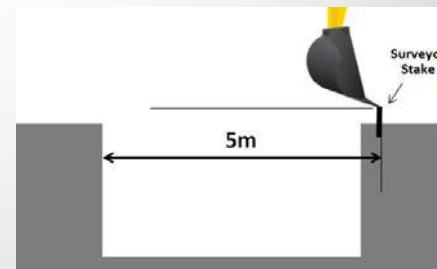

→ Dial-in **-5m**

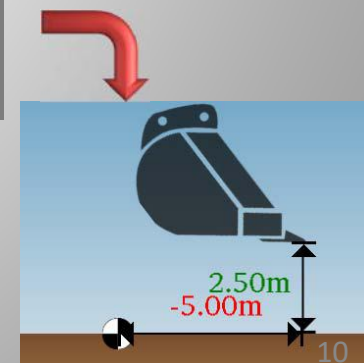

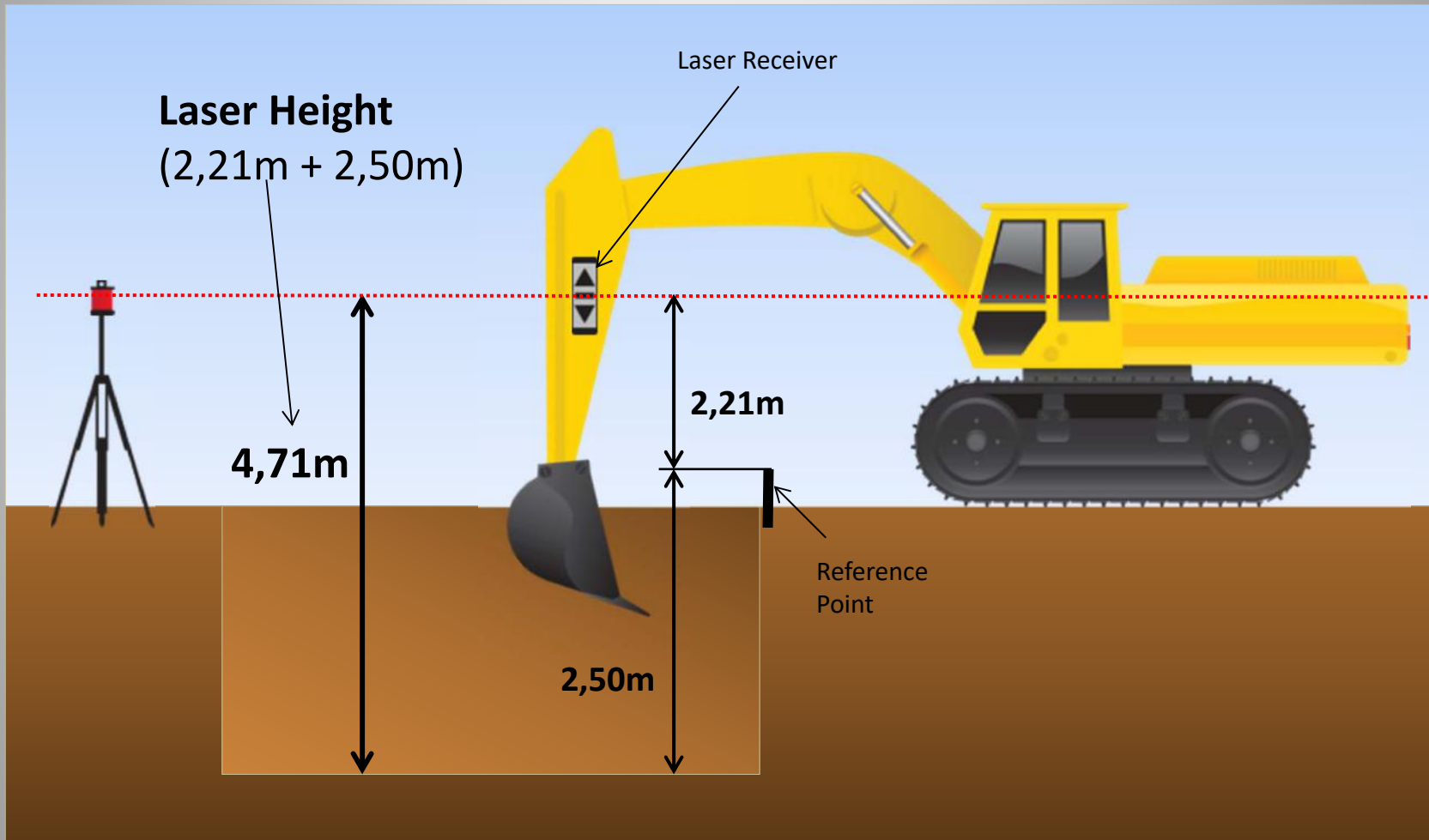



DIGGING A MANHOLE using a rotating laser

Method 1: Knowing the Laser Height

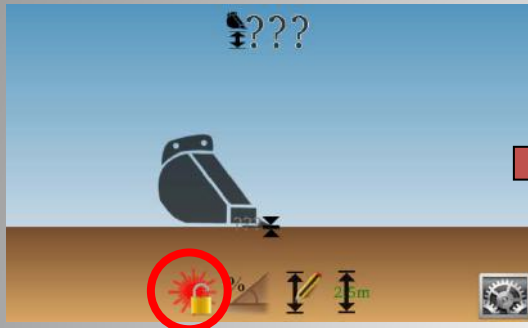

Activate the 1st laser catch

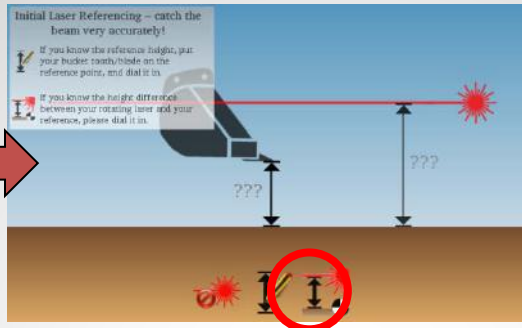

Click on « Set Laser Height »

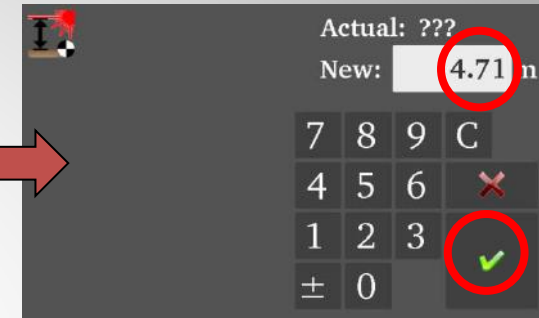

Dial-in « 4.71m » and validate

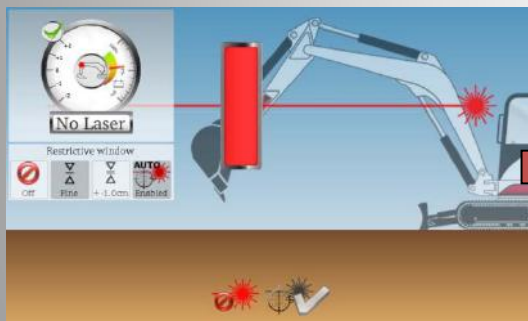

Catch the laser beam

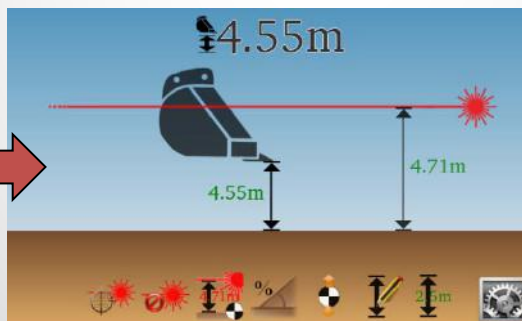

→ The laser height previously set is shown (4,71m) and the result of the calculation after the laser catch shows in this example that the bucket tip actually is 4,55m above grade.

Each time the machine gets moved, click on the button below to catch the laser beam again:

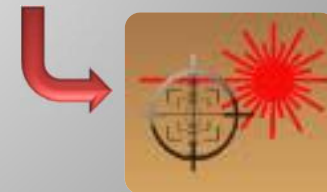



DIGGING A MANHOLE using a rotating laser

Method 2: Not knowing the Laser Height

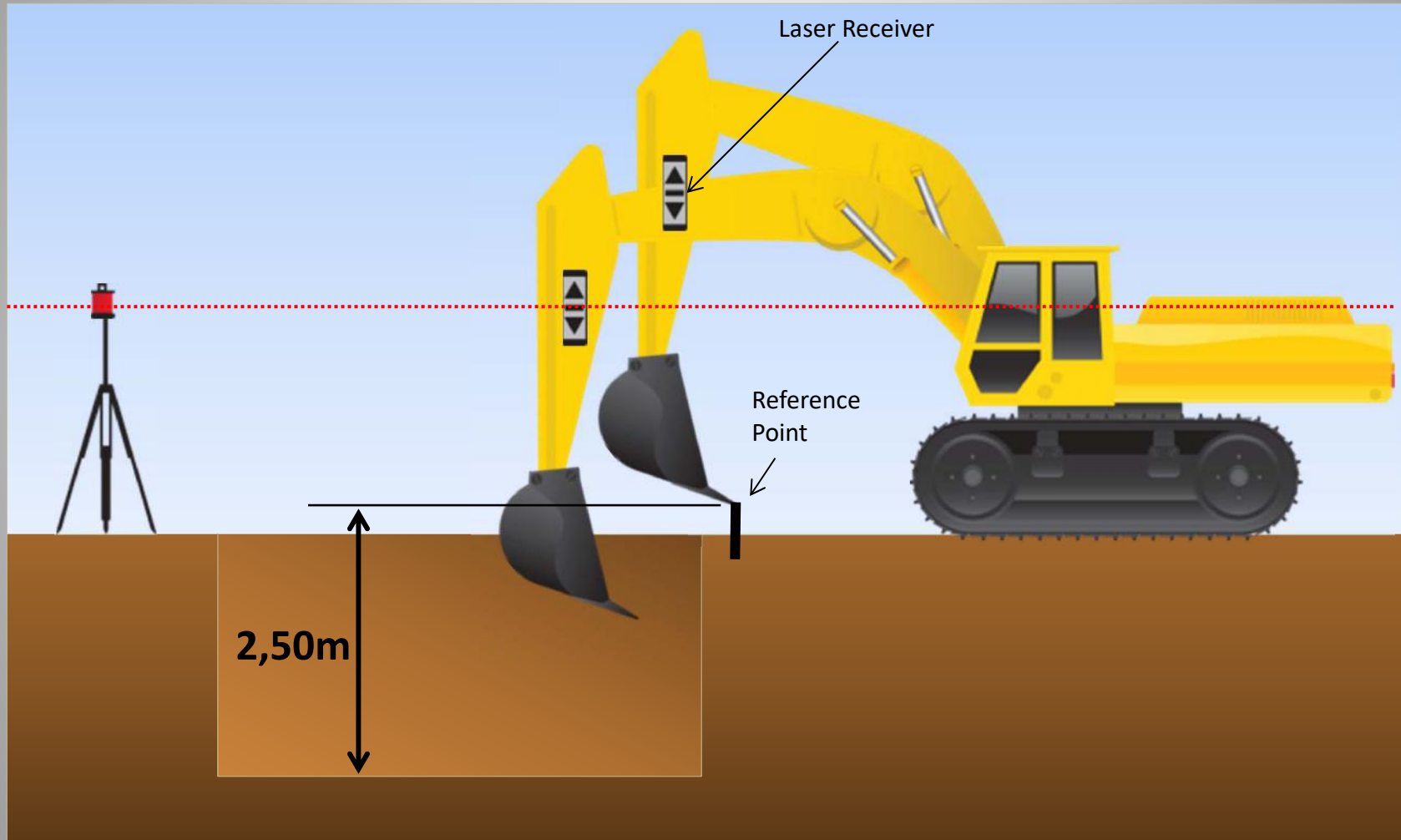

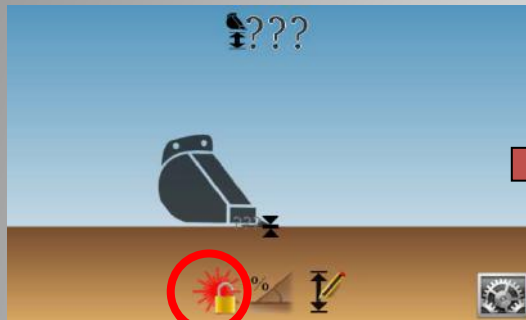

Activate the 1st laser catch

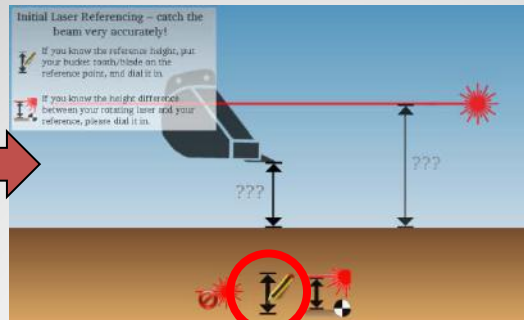

Click on « Bucket Height »

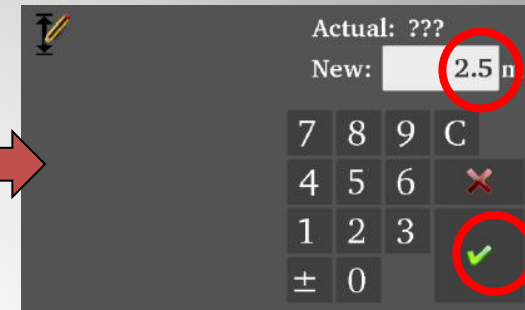

Place the tip of the bucket on the point of reference and then enter '2.5m', finally confirm.

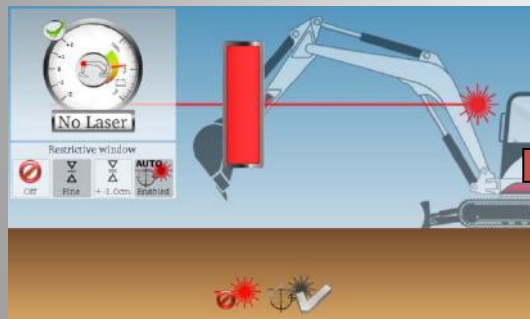

Catch the laser beam

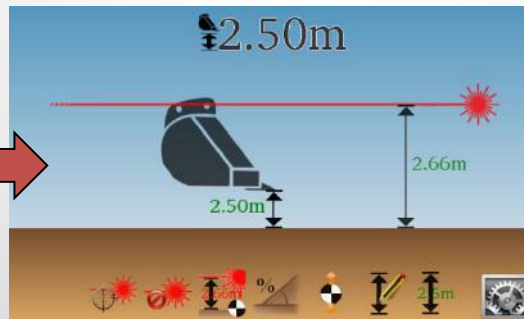

→ The bucket height is shown (2,50m) and the result of the calculation after the laser catch shows in this example that the Laser Height is 2,66m.

Each time the machine gets moved, click on the button below to catch the laser beam again:





DIGGING A TRENCH with 2% slope
Method 1: Using the bottom of the trench as the reference

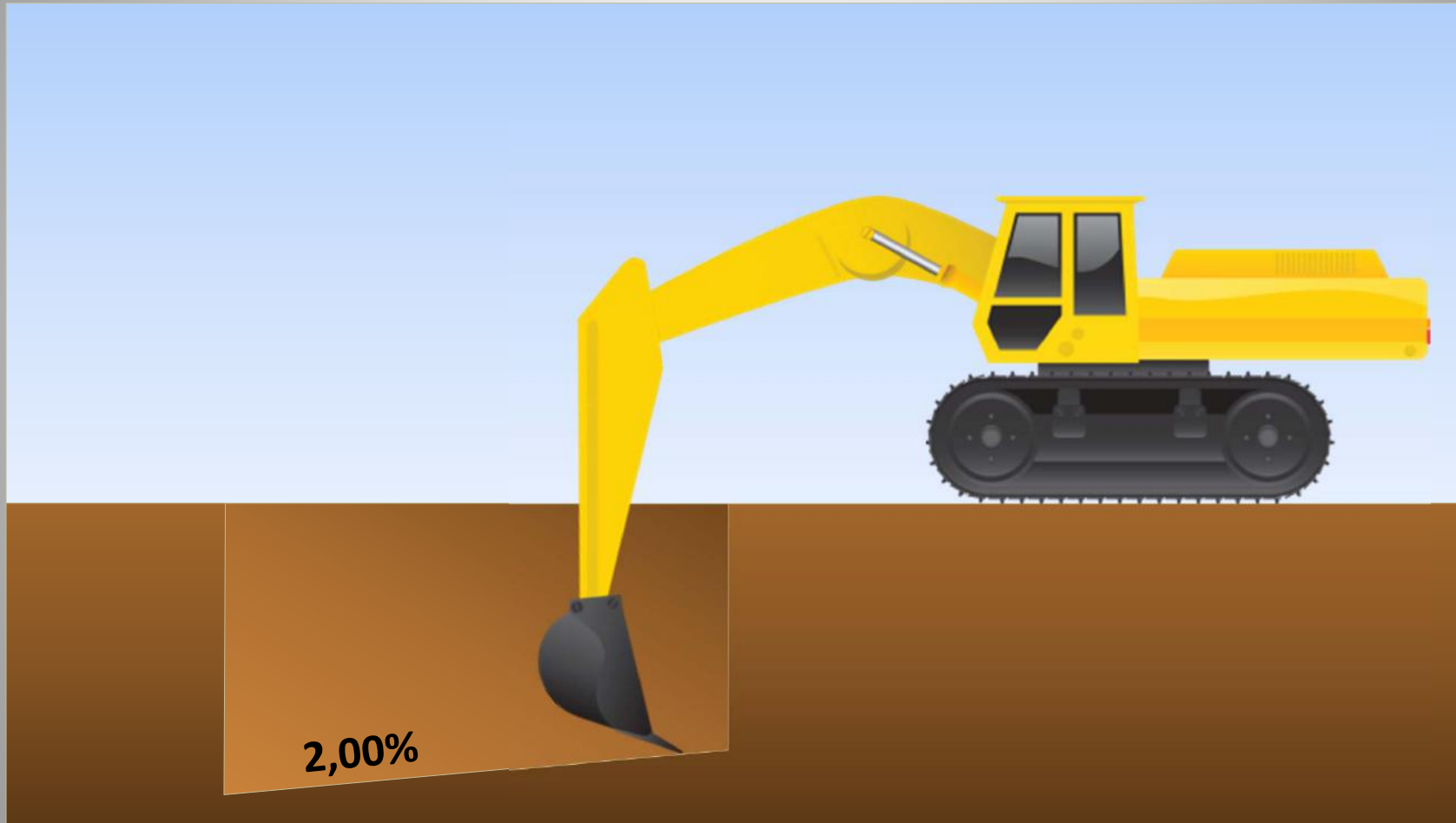

DIGGING A TRENCH with 2% slope

Method 1: Using the bottom of the trench as the reference

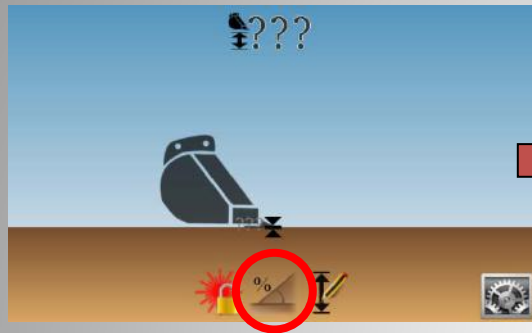

Click on « Slope Setting »

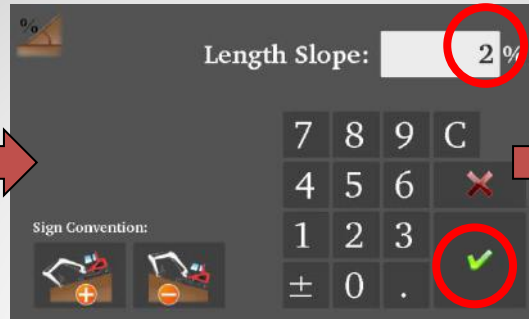

Choose the direction of the slope on the bottom left. Enter 2.00% and validate

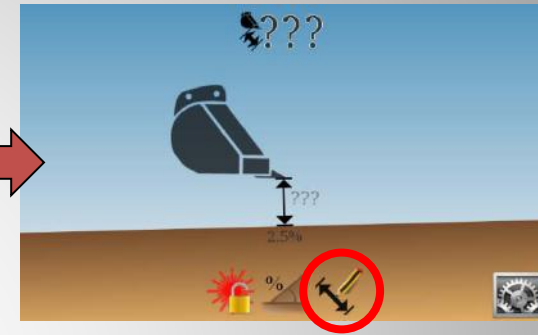

Note: If you're using the 2D sensor, first align the cabin to the slope.

Place the tip of the bucket at the bottom of the trench and then press the symbol "Elevation"



Enter '0' as the height (you are at the bottom of the trench) then validate.



Watch the on-screen instructions to follow the set slope.

Note: without 2D sensor, you have to dig parallel to the axis of the set slope. Turning the cabin causes an immediate error of calculation.



*DIGGING A TRENCH with 2% slope
Method 2: Using (e.g.) a surveyor's stake as the reference*

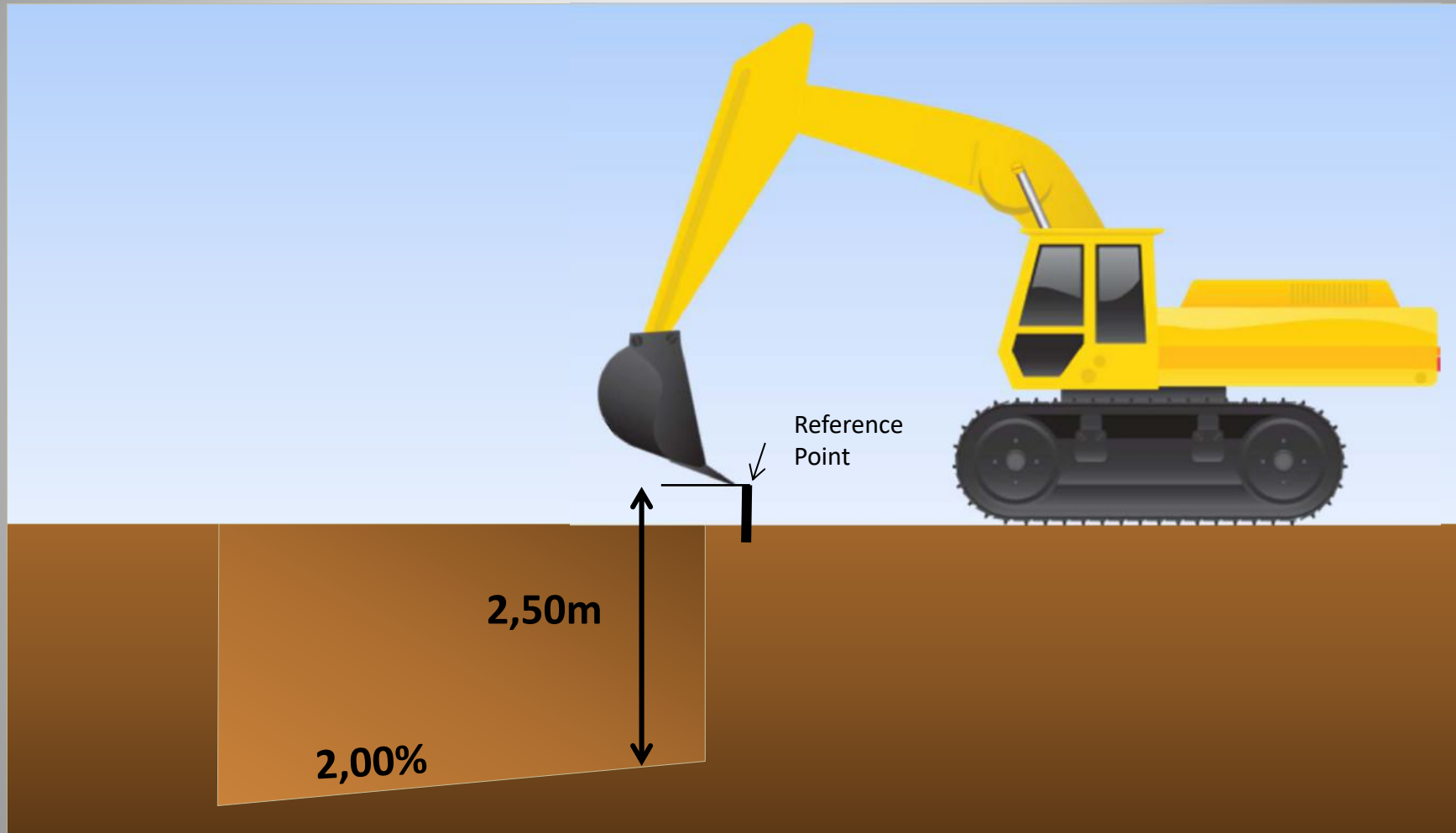

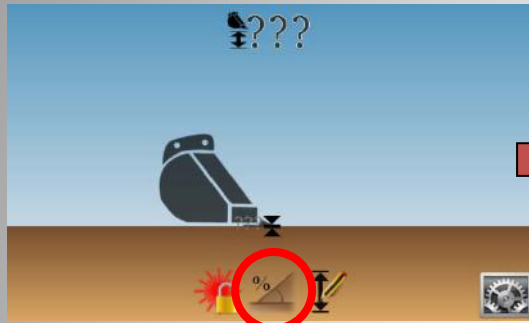

Click on « Slope Setting »

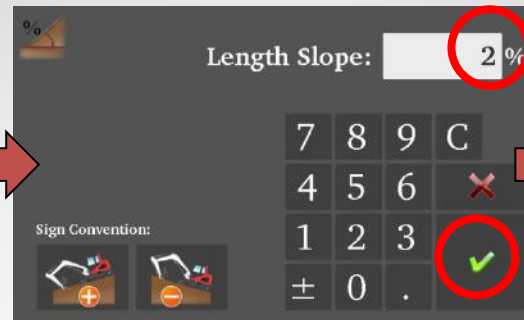

Choose the direction of the slope on the bottom left. Enter 2.00% and validate

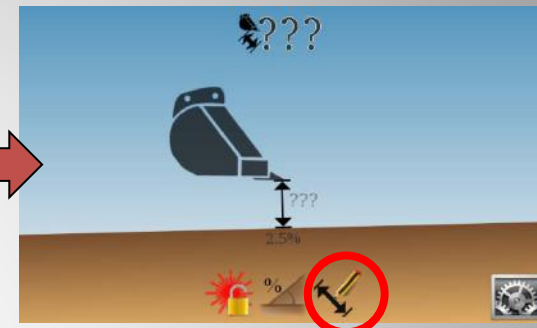

Note: If you're using the 2D sensor, first align the cabin to the slope.

Place the tip of the bucket on the reference point and then press the symbol "Elevation"



Enter '2,50m' as the height (you are 2,50m higher than the bottom of the trench) then validate.

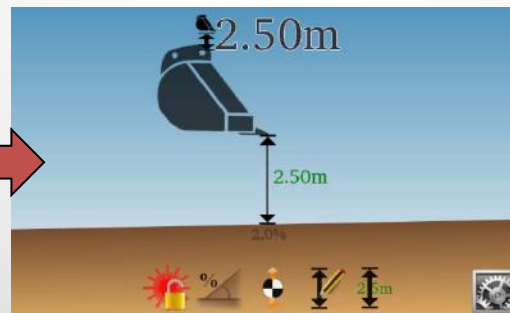

Watch the on-screen instructions to follow the set slope.

Note: without 2D sensor, you have to dig parallel to the axis of the set slope. Turning the cabin causes an immediate error of calculation.



DIGGING A TRENCH with 2% slope using a rotating laser Method 1: Knowing the Laser Height

Note:
You must set the same slope in the rotating laser as in the iDig system and align it to the same axis.

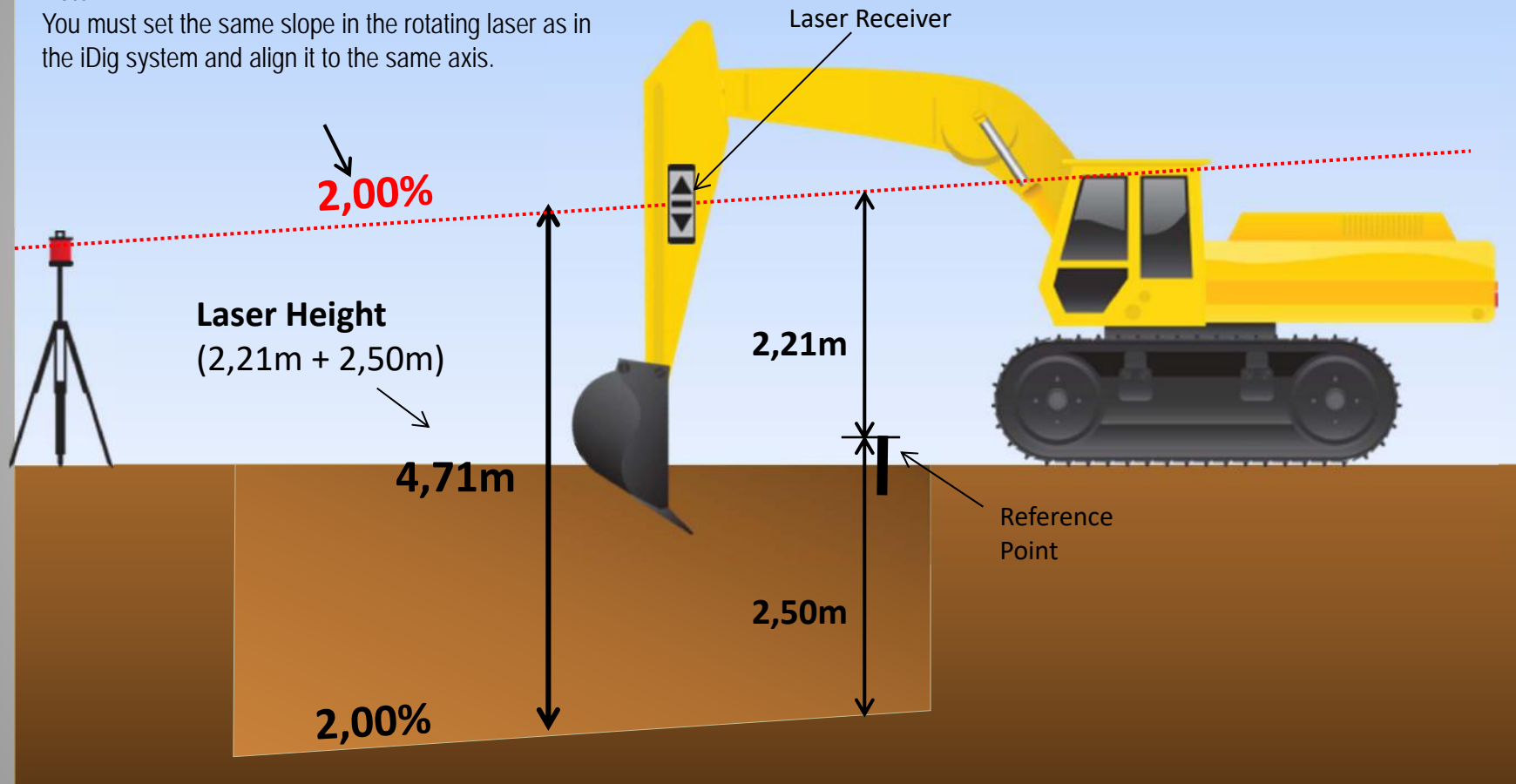



DIGGING A TRENCH with 2% slope using a rotating laser

Method 1: Knowing the Laser Height

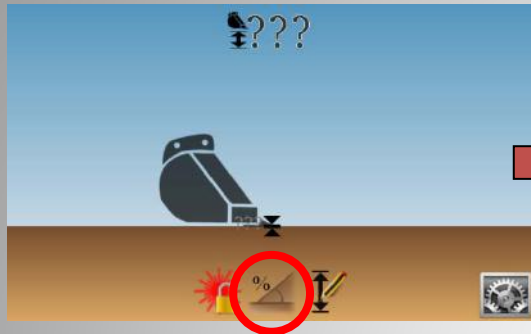

Click on « Slope Setting »

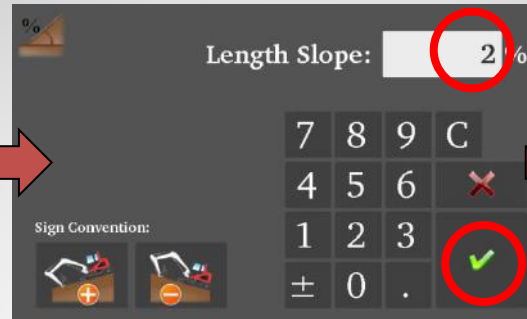

Choose the direction of the slope on the bottom left. Enter 2.00% and validate.

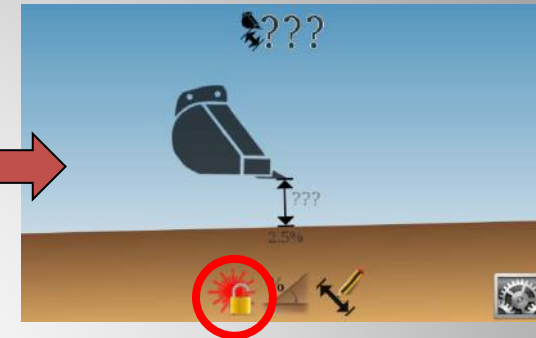

Note: If you're using the 2D sensor, first align the cabin to the slope.
Activate the 1st laser catch

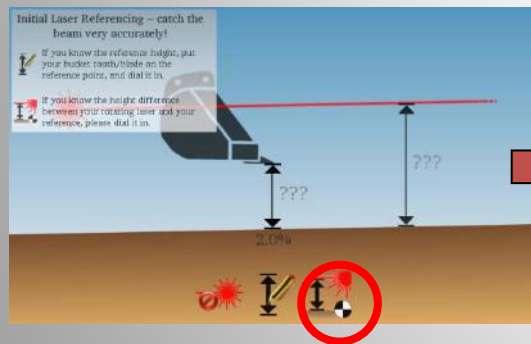

Click on « Set Laser Height »

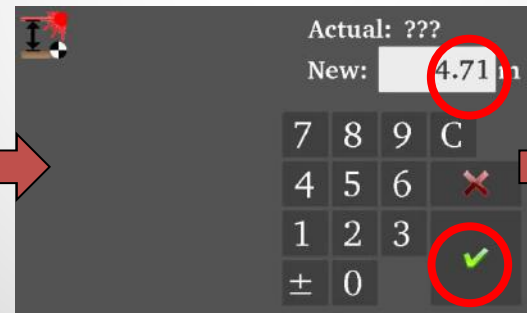

Dial-in « 4.71m », validate, and catch the laser beam.



→ The laser height previously set is shown (4,71m) and the result of the calculation after the laser catch shows in this example that the bucket tip actually is 4,38m above grade.



DIGGING A TRENCH with 2% slope using a rotating laser Method 2: Not knowing the Laser Height

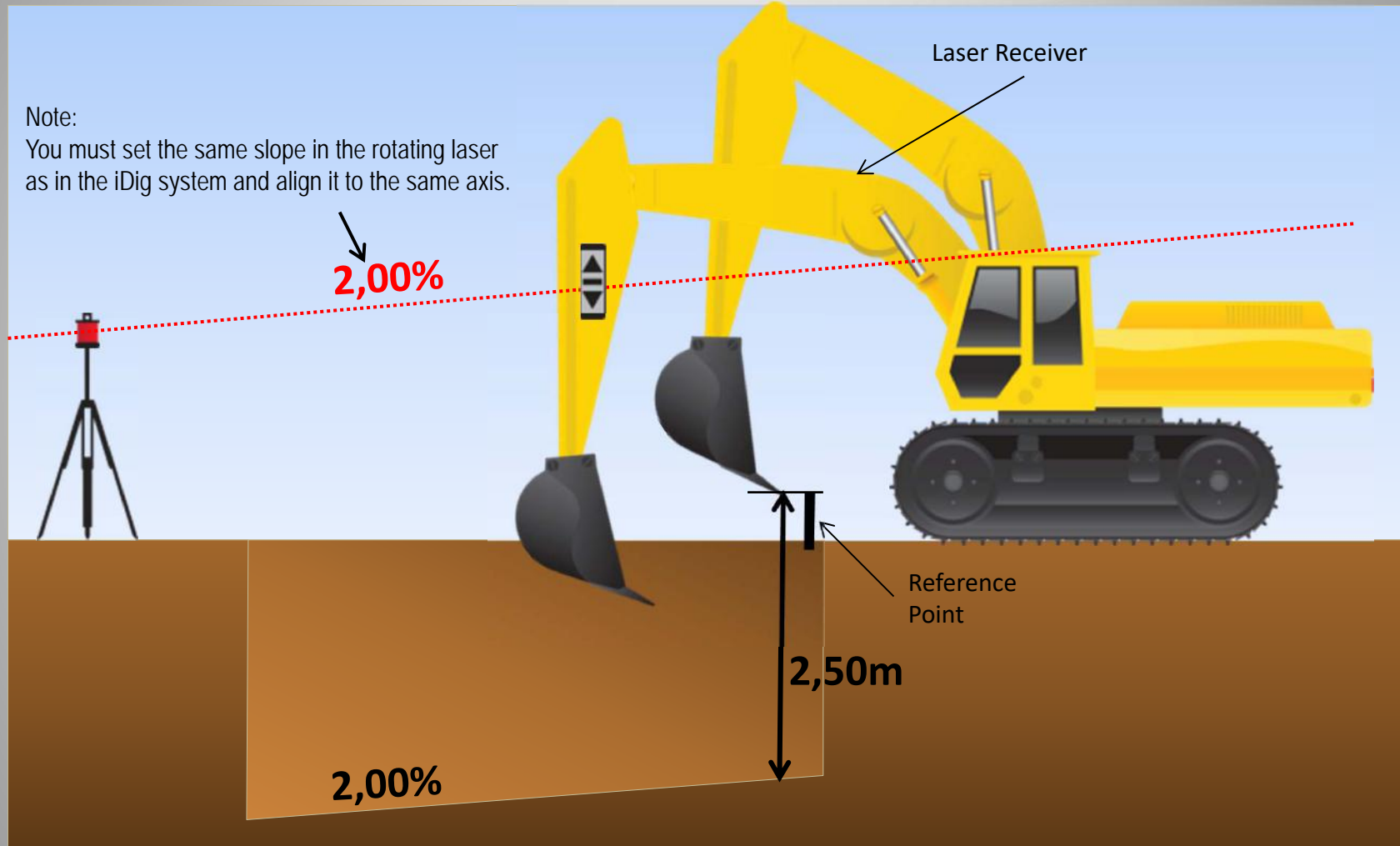



Click on « Slope Setting »

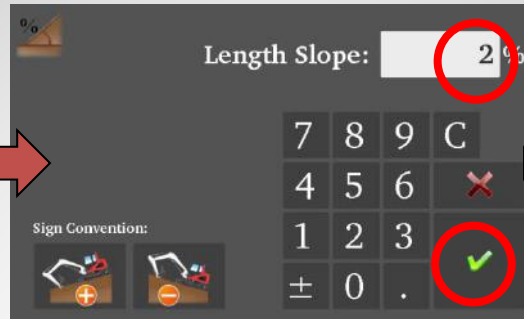

Choose the direction of the slope on the bottom left. Enter 2.00% and validate.

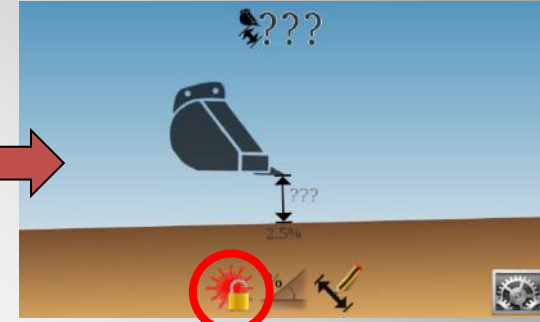

Note: If you're using the 2D sensor, first align the cabin to the slope.
Activate the 1st laser catch

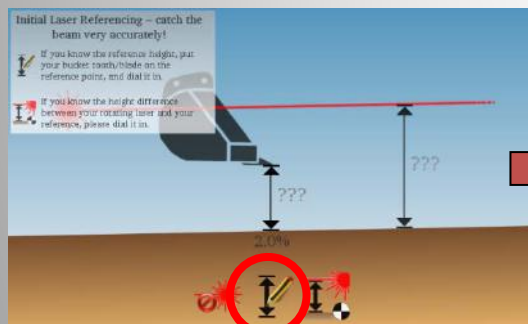

Click on « Bucket Height »

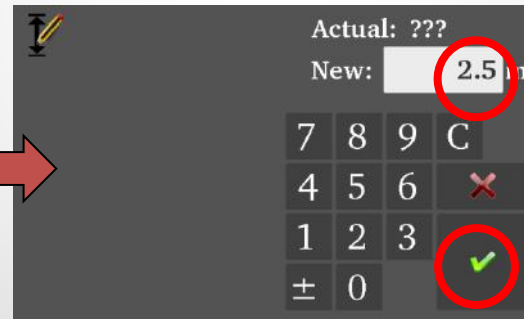

Place the tip of the bucket on the point of reference and then enter '2.5m', confirm, and catch the laser beam.

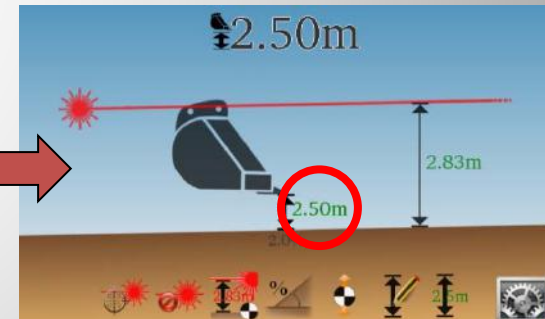

→ The bucket height is shown (2,50m) and the result of the calculation after the laser catch shows in this example that the Laser Height is 2,83m.

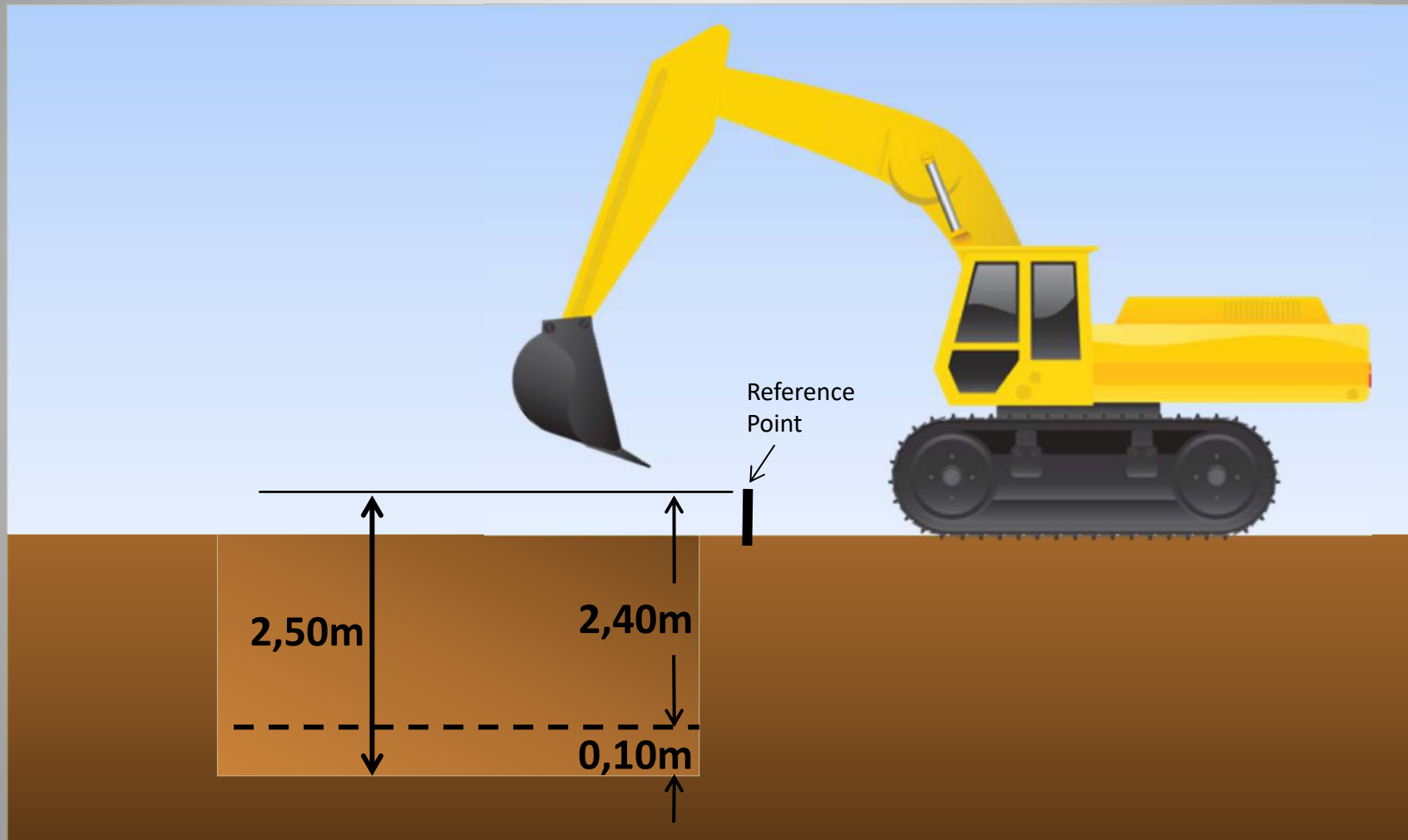

Possibility 1 : Changing the elevation → by changing directly the digging depth



Place the bucket on a known height (here 2,50 m), then click on "Elevation Setting".

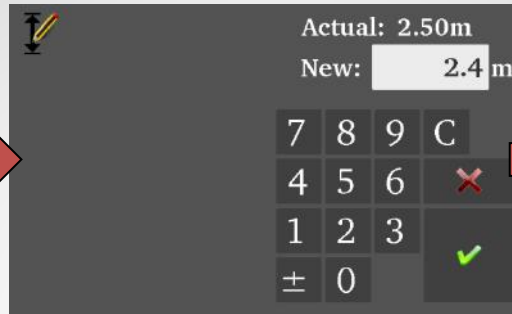

Enter a new height, 10cm HIGHER than the current height (2,50m → 2,40m), then validate.



The bucket is still on the original reference, but the digging depth has been DECREASED 10cm.

Possibility 2 : Changing the elevation → by dialing-in an offset



Click on the button 'Move the Reference' and then click the "Raise" button.

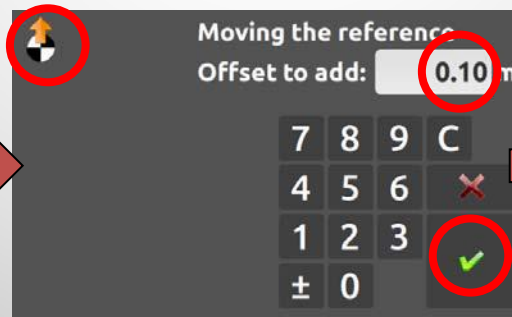

Dial-in the offset, in this case 0,10m.



The digging depth has been RAISED 10cm.

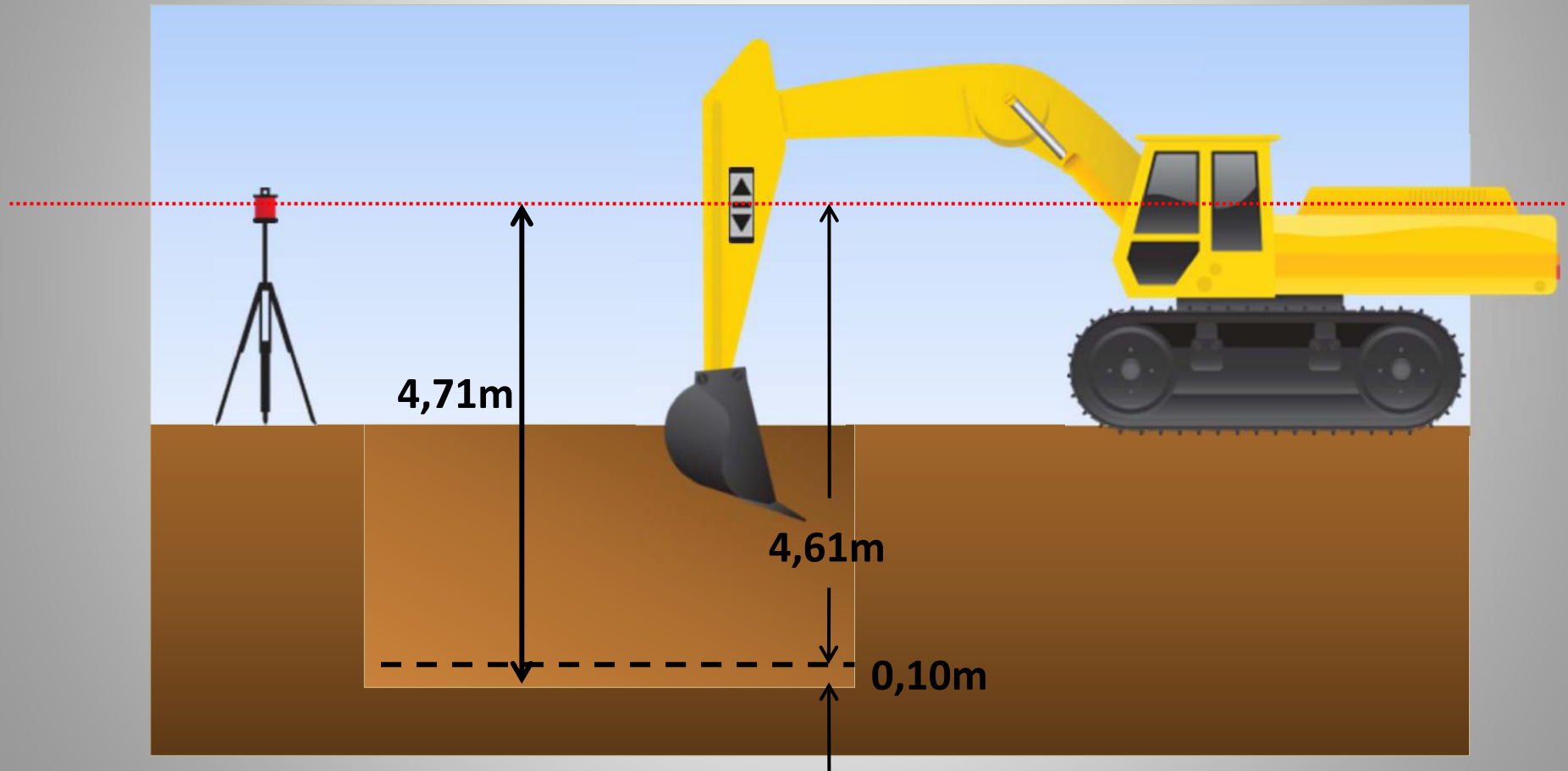

Possibility 1: Change directly the digging depth

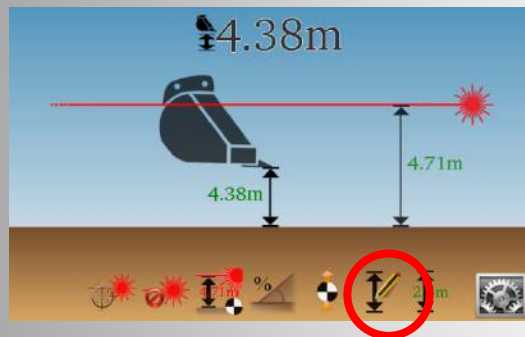

Place the bucket on a known height (here 2,50 m), then click on "Elevation Setting".

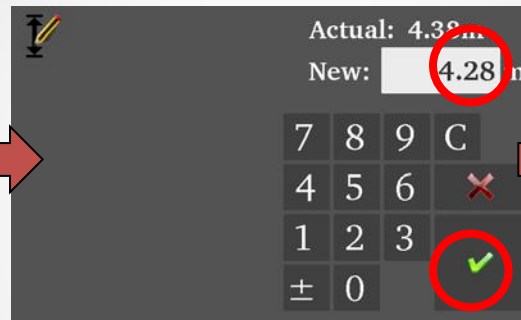

Enter a new height, 10cm LOWER than the current height (4,38m → 4,28m), then validate.



The digging depth has been RAISED 10cm.

Possibility 2: Change directly the Laser Height



Click on « Set Laser Height »

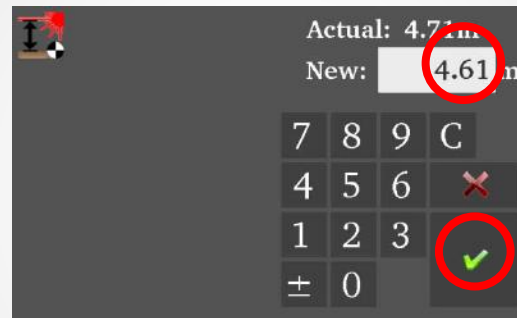

Enter a new Laser Height, 10cm LOWER than the current height (4,71m → 4,61m), then validate.



The bucket height / reference and Laser Height decreased by 10 cm.

Possibility 3 : Dial-in an offset

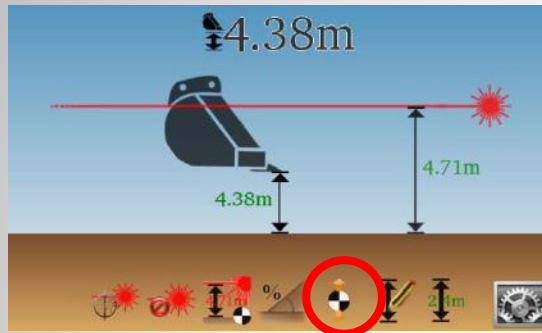

Click on the button 'Move the Reference'

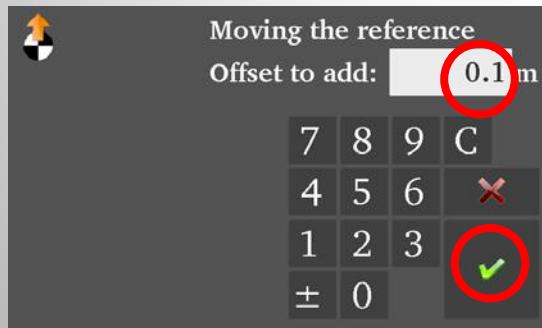

Dial-in the offset, in this case 0,10m.

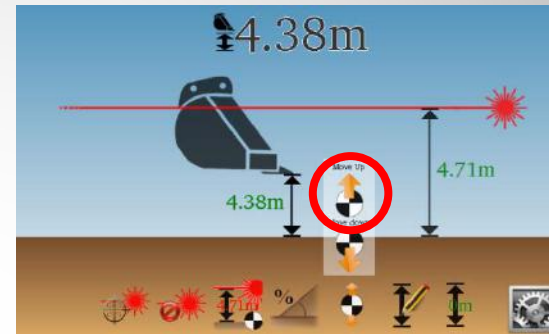

Click the "Raise" button.



The bucket height / reference and Laser Height decreased by 10 cm.

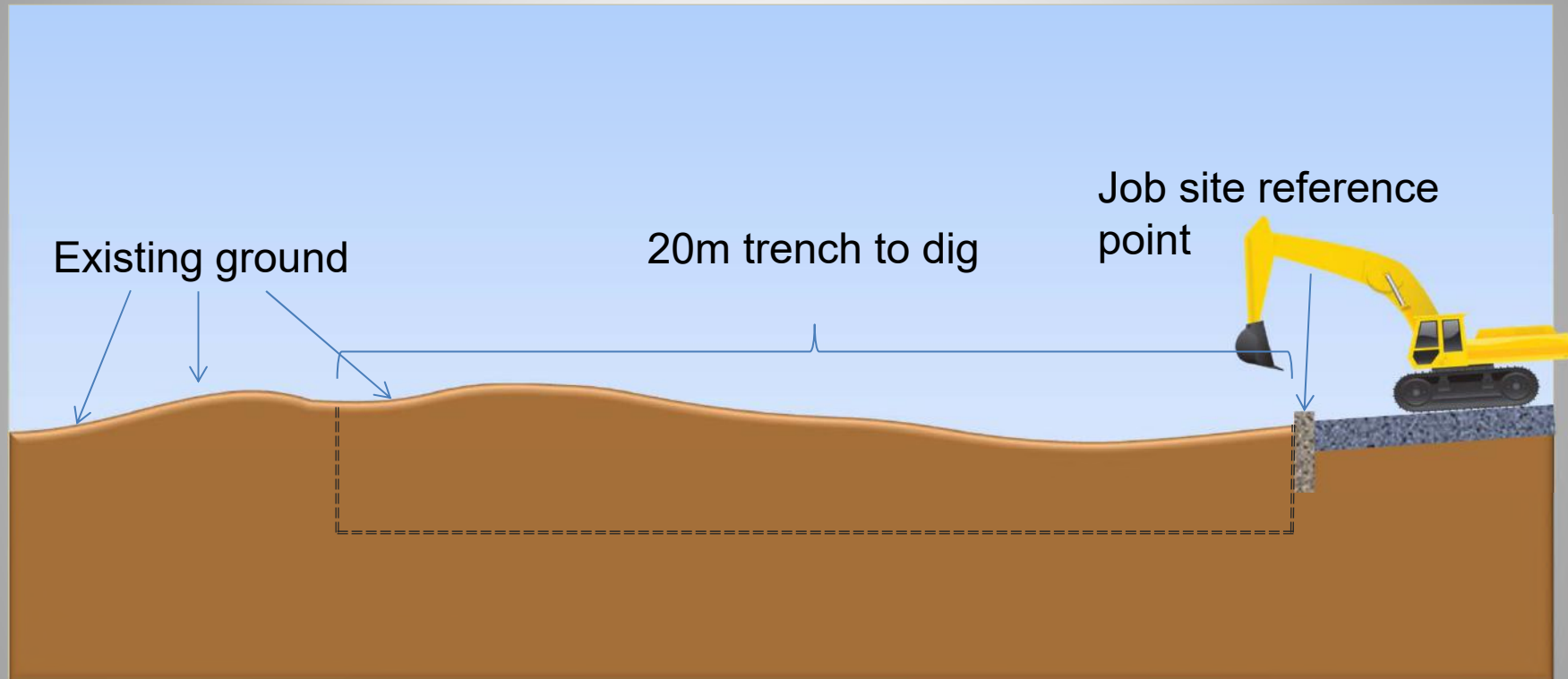

On this job site, a 20 m long trench, 2 m below the reference point on a sidewalk, has to be built.

Moving the machine

Set reference

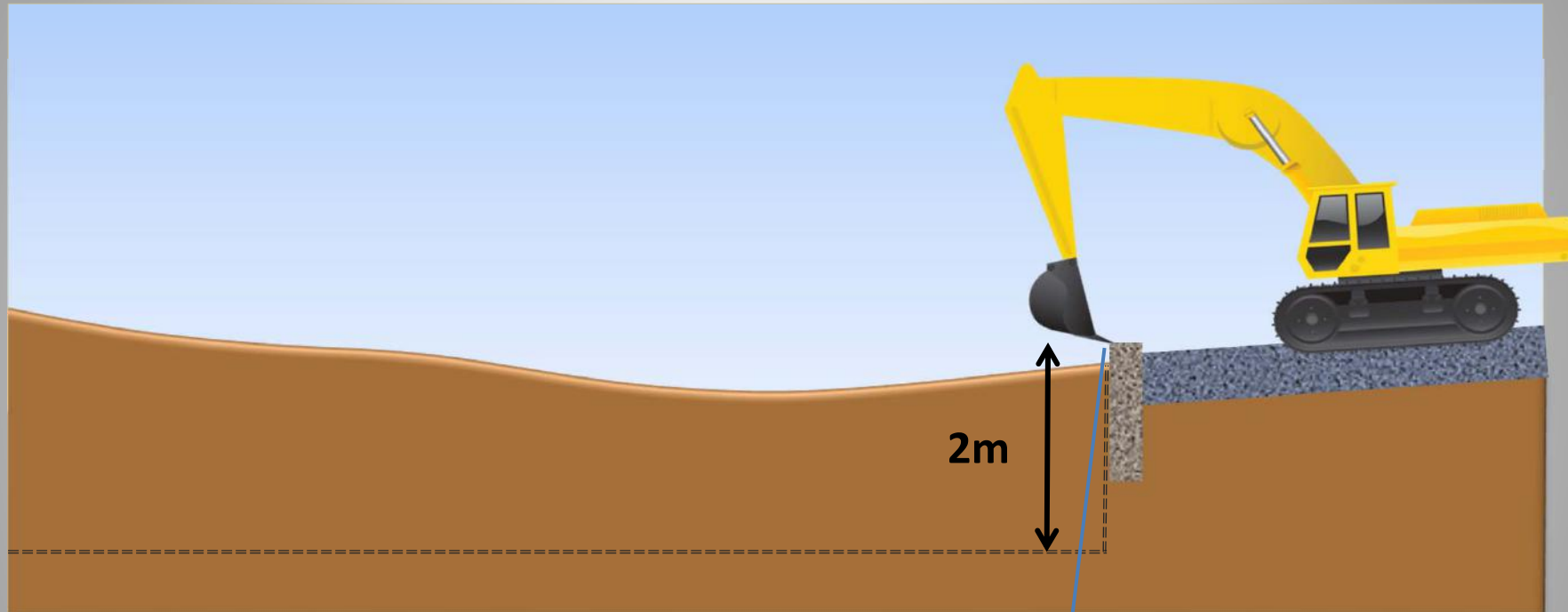

- Verify that no slope is set (0%)
- Put the bucket tip on the reference point
- Change the elevation
- Enter 2m and validate





Moving the machine

Start digging

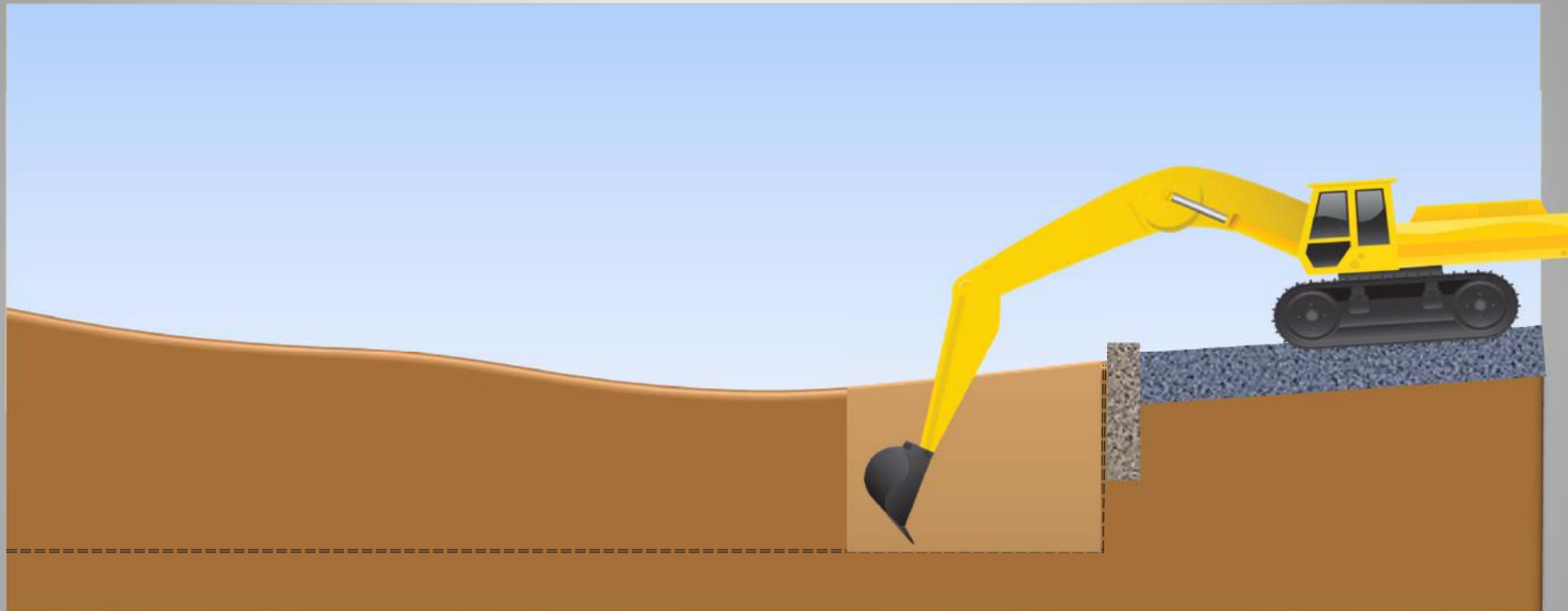

- Start digging following the indications of the system.
- Your machine is not on an even surface, do not move the tracks!



Moving the machine

Re-reference with the bucket tip

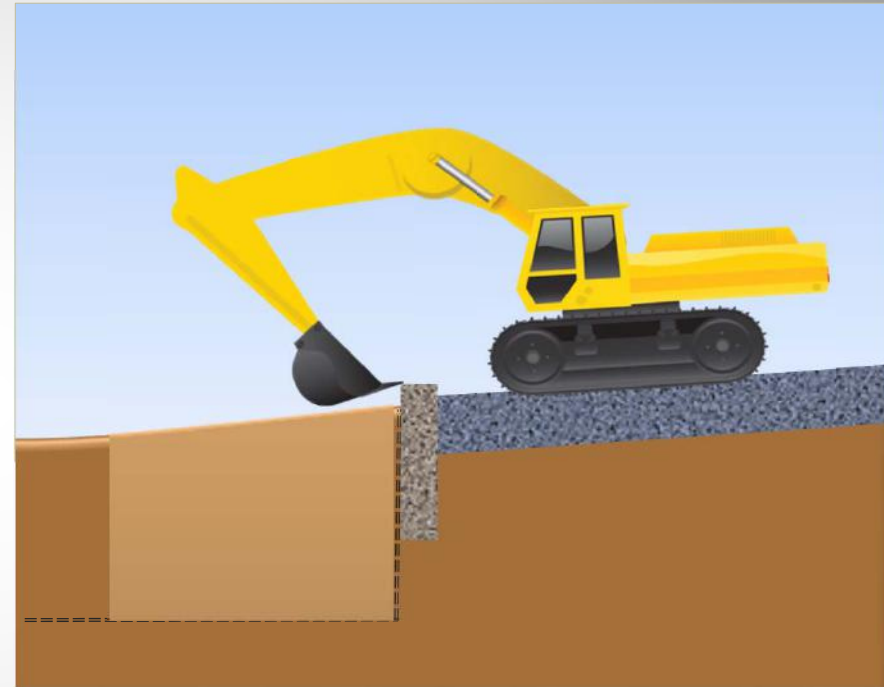
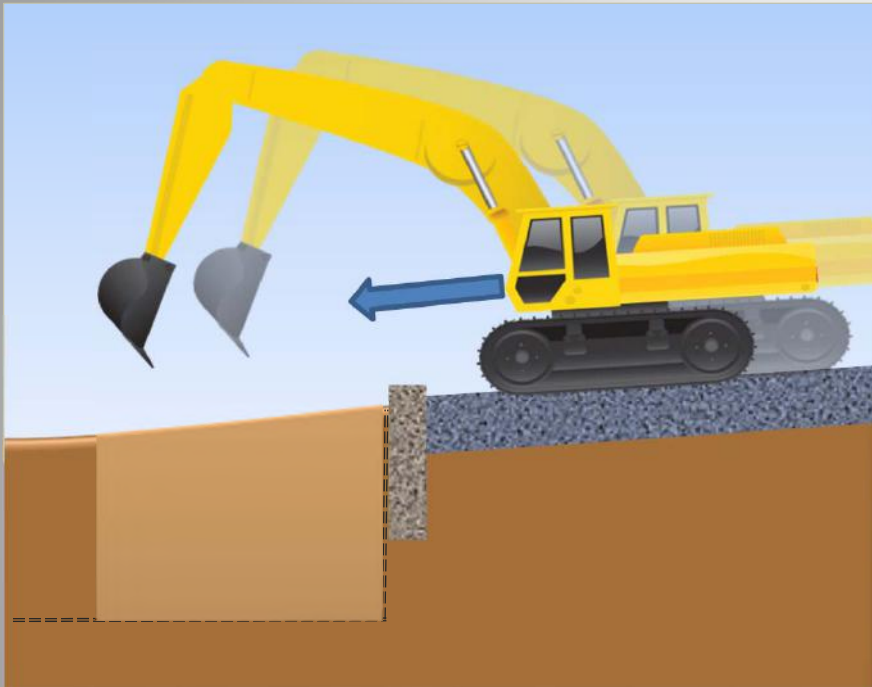

- To continue, move the machine forward
- Put back the bucket tip on the reference point
- Click the « Quick Elevation » button to re-reference the machine:



Moving the machine

Re-reference with the bucket tip

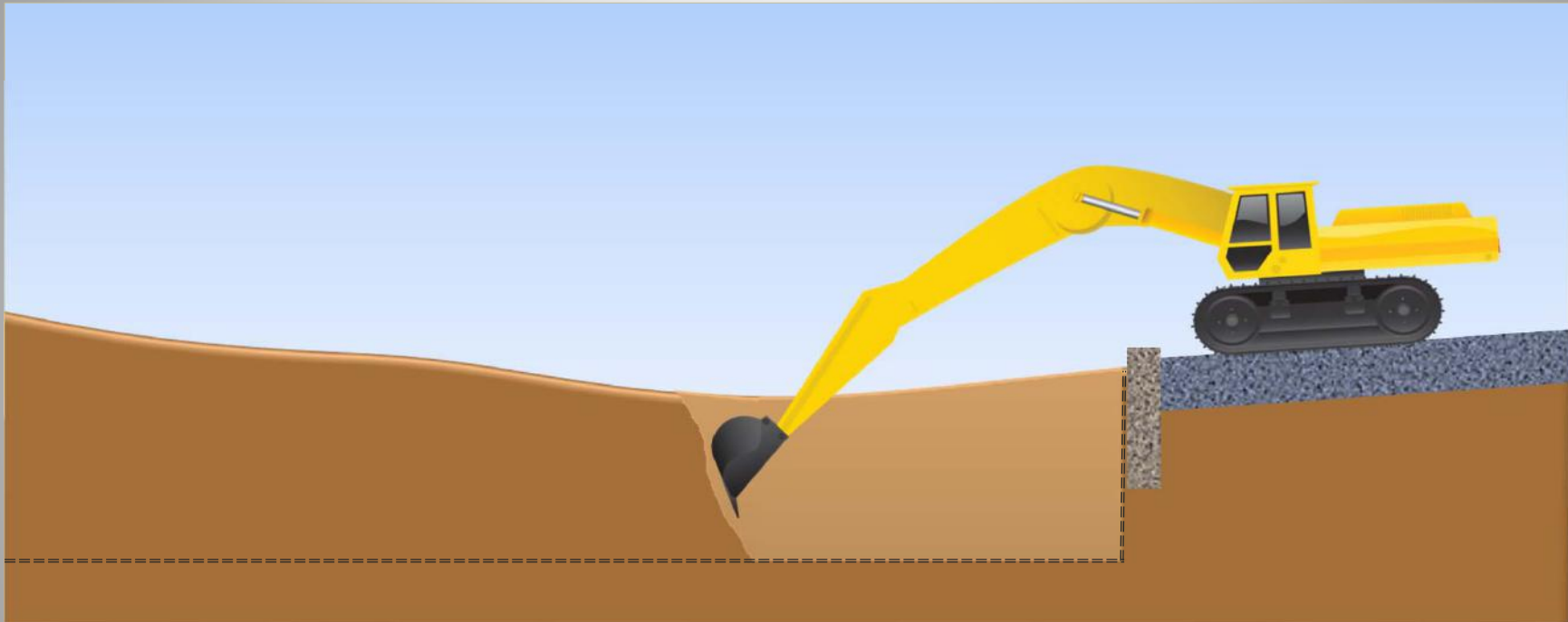

- Continue digging, using the entire range of the elements to reduce the number of moves with the machine.



Moving the machine

Re-reference with the bucket tip

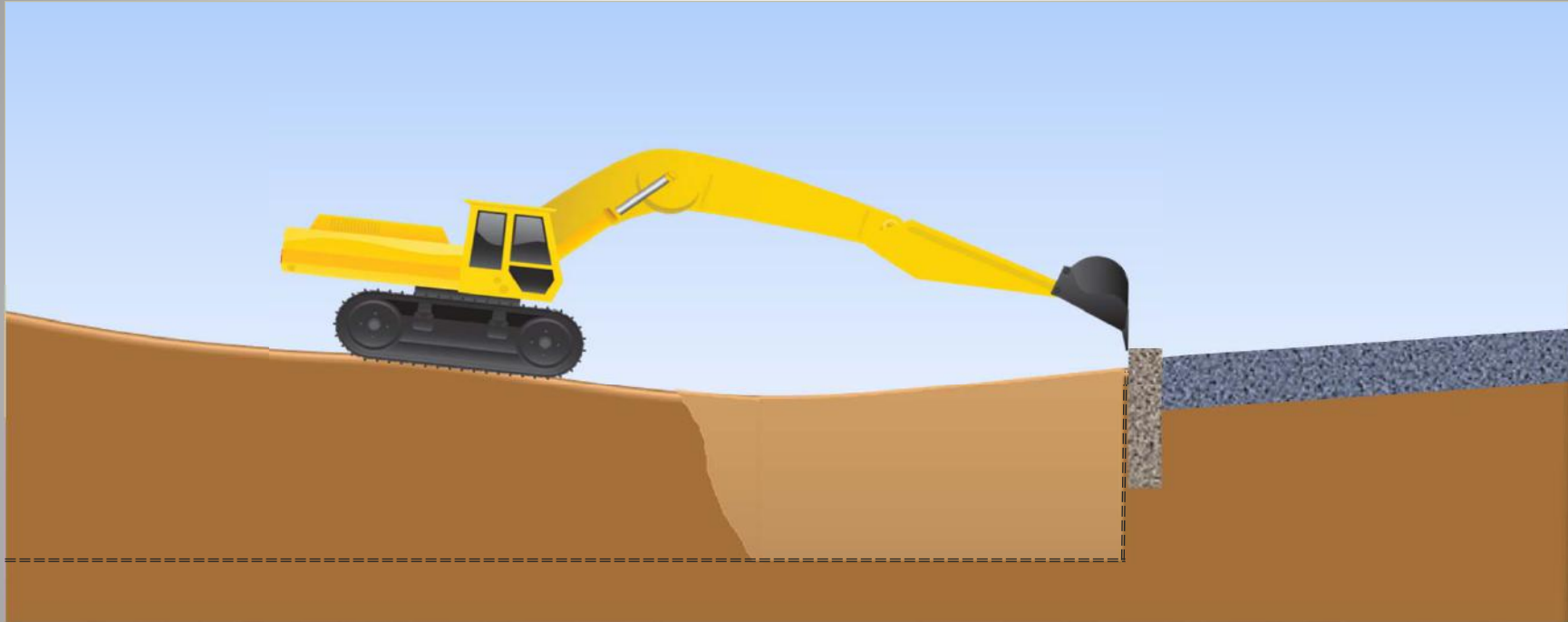

- As long as possible, put back the bucket on the reference point after the machine got moved
- Click the « Quick Elevation » button to re-reference the machine:
- And continue to work





Moving the machine

Reference point out of reach of the bucket tip

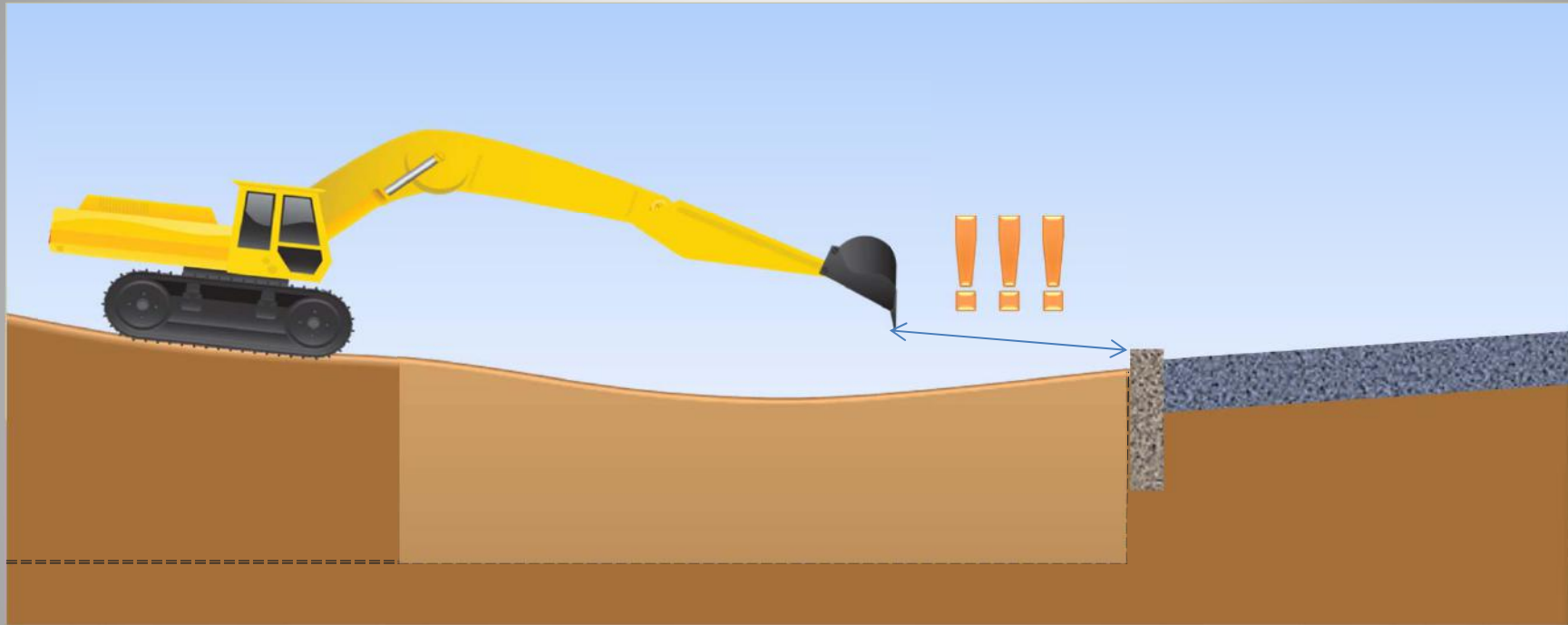

- Now, you are too far away from the reference point.
- Without rotating laser, you may re-reference on the ground (on a supposedly good elevation), but on long distance inaccuracies may add-up.
- It's time to use a rotating laser!!!



Moving the machine

Reference point out of reach of the bucket tip

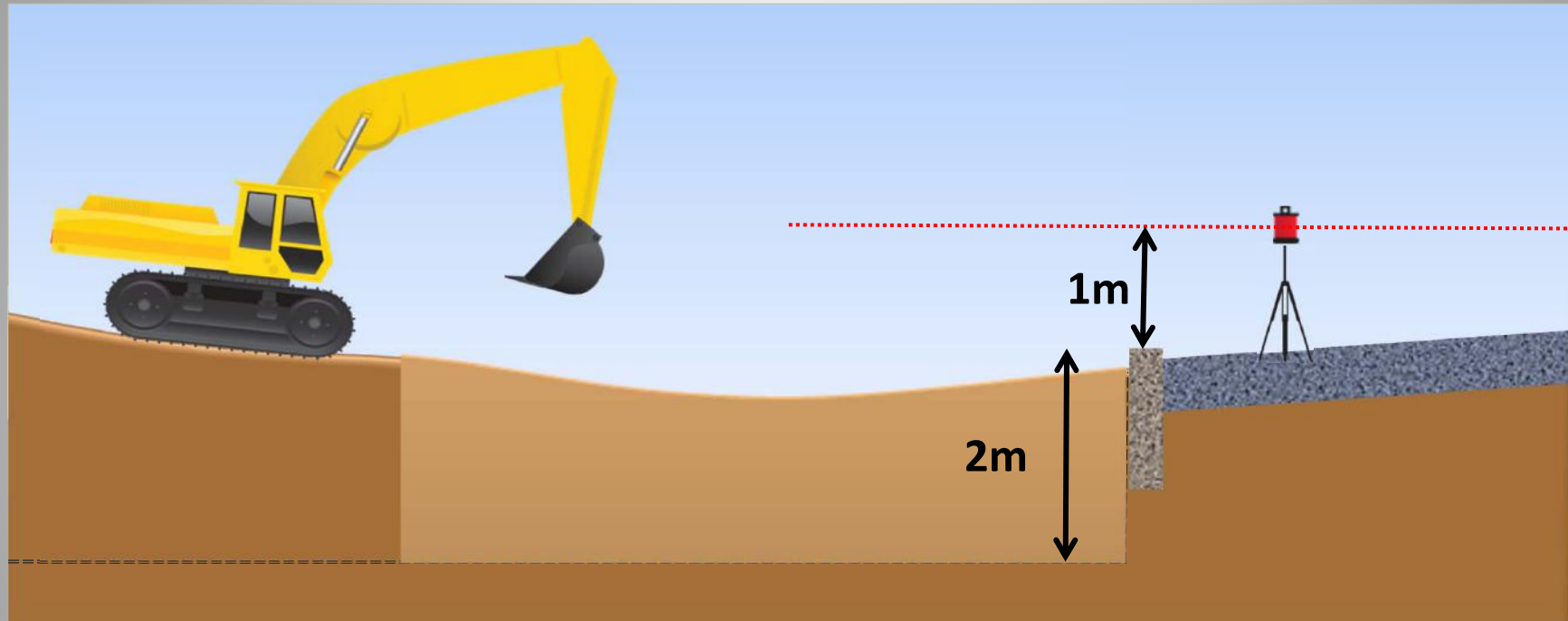

- Setup the rotating laser.
- Measure the elevation difference between the laser plane and the reference point.
- In this example, the elevation difference to the reference point is 1,00m, PLUS 2,00m elevation difference to the ground, **makes a total of 3,00m.**

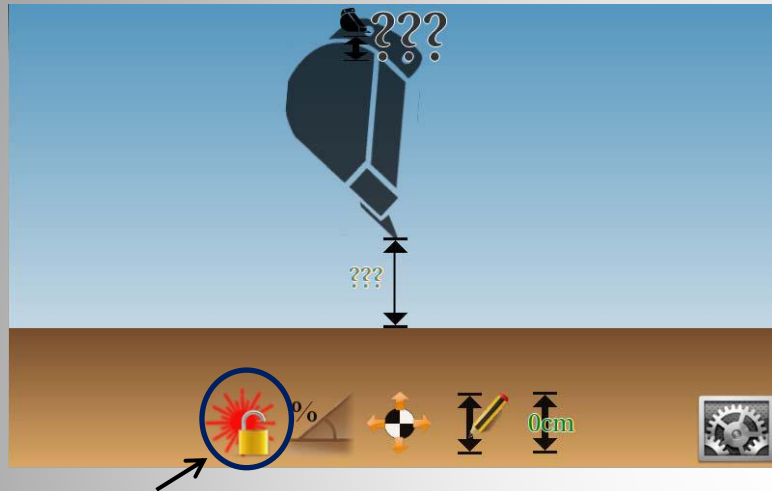

The laser function is available but not yet initialized.

→ Click the « 1st Laser Catch » button

Note:

- If no laser button is visible, then the laser receiver needs to be calibrated.
- If several laser buttons are visible, then there is an “old” 1st laser catch existing. Delete this “old” catch to initialize a new 1st laser catch:

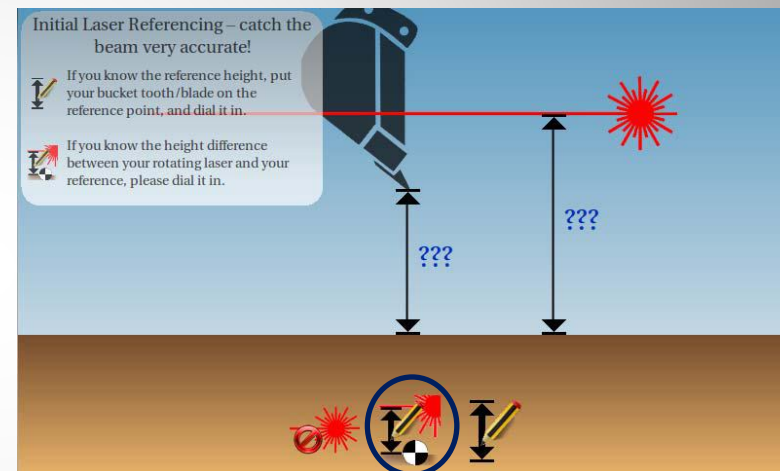
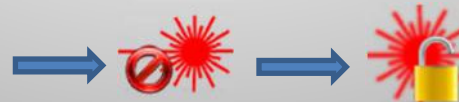

Click on “Set Laser Height”



Moving the machine

Reference point out of reach of the bucket tip

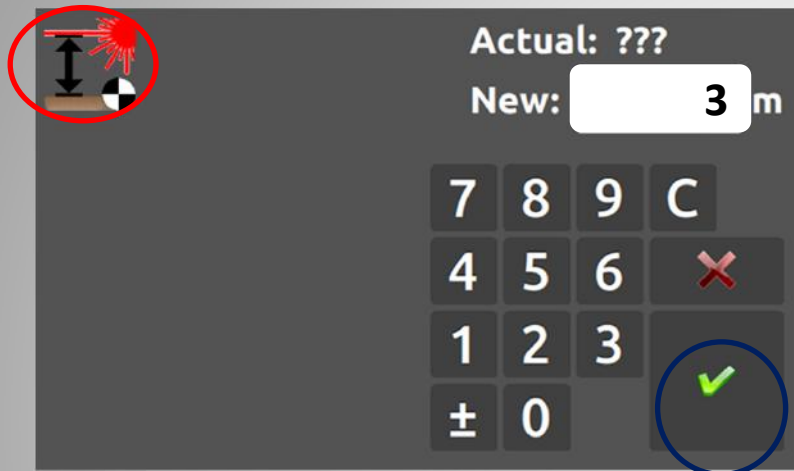

- Enter the Laser Height:
« 3,00m » and validate.

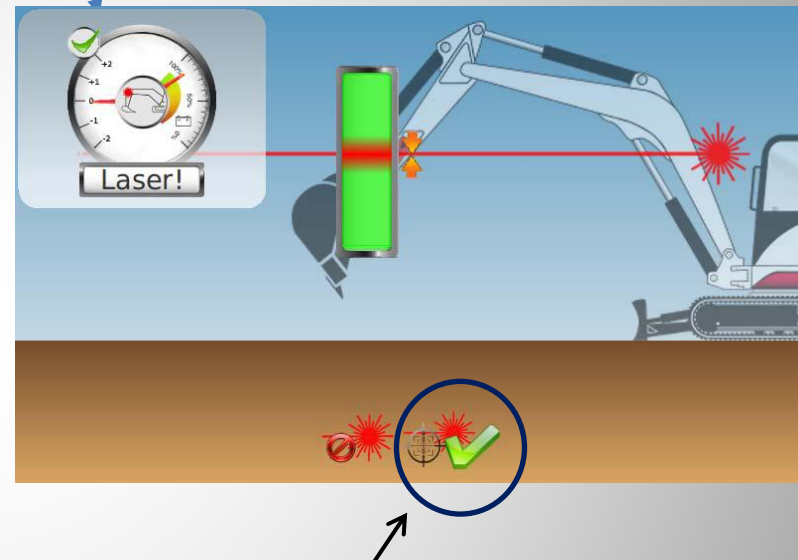

- Now catch the laser beam and click on « Next ».

Note: If the 'AutoCatch' option is enabled you do not need to click "Next".



Moving the machine

Reference point out of reach of the bucket tip

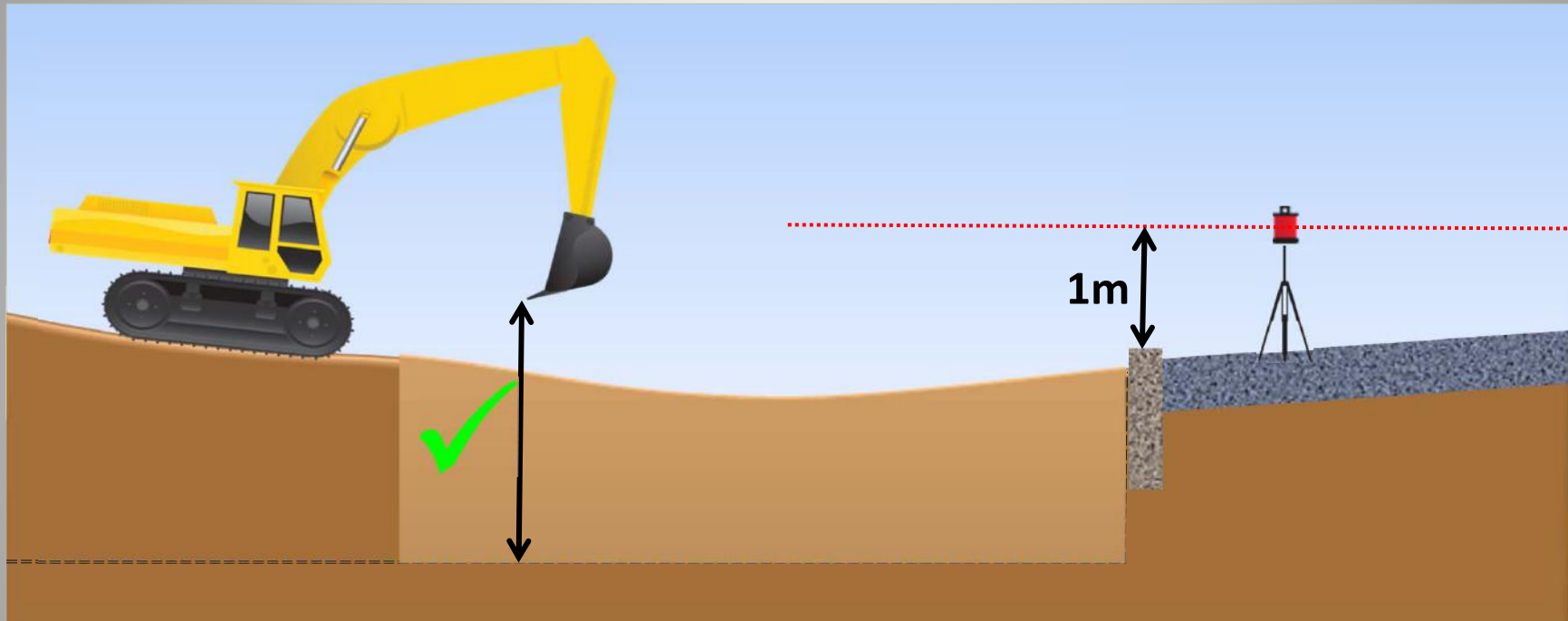

- You're now able to re-reference each machine move by catching again the laser.
- You may continue digging.



Moving the machine

Each time you moved the machine...

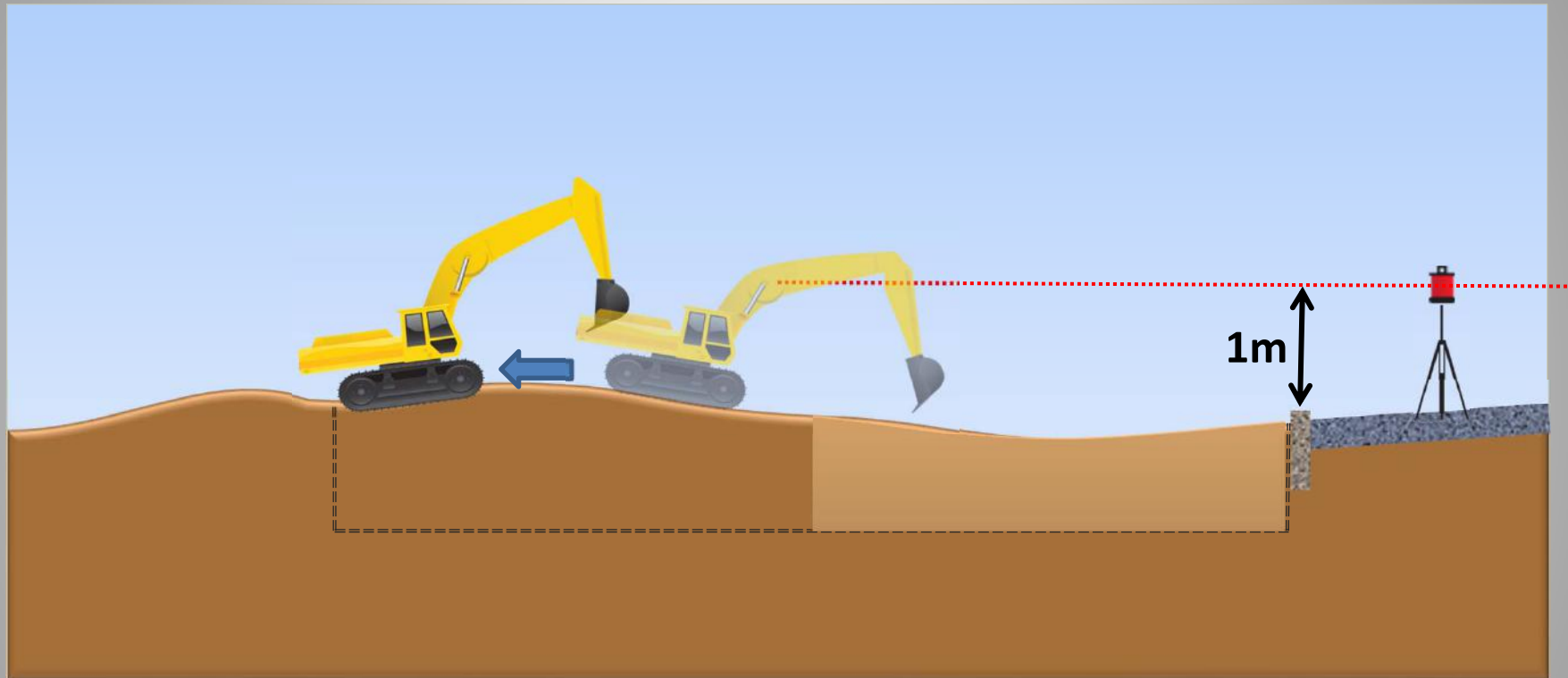

- You need to move again.
- The Laser Height is already set & defined.

Moving the machine

Each time you moved the machine...

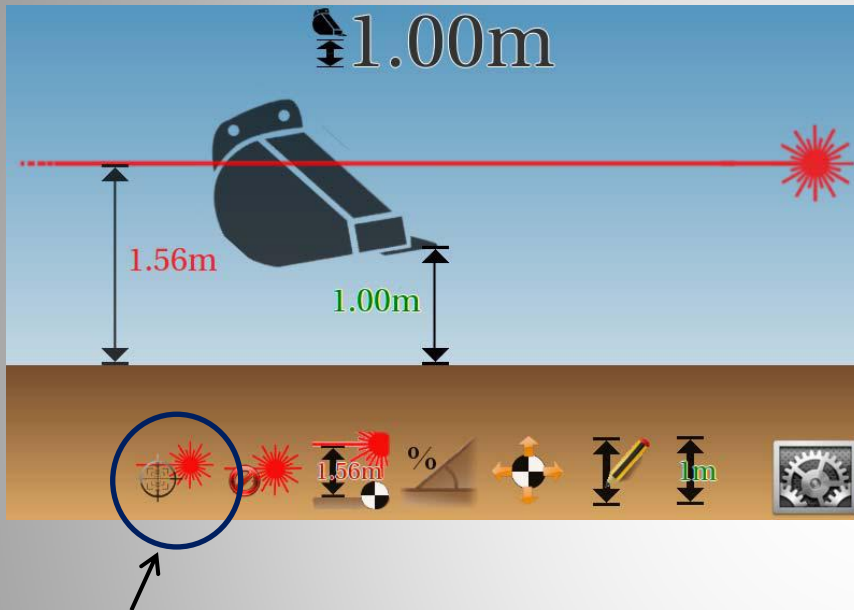

- After the machine got moved, make another laser catch

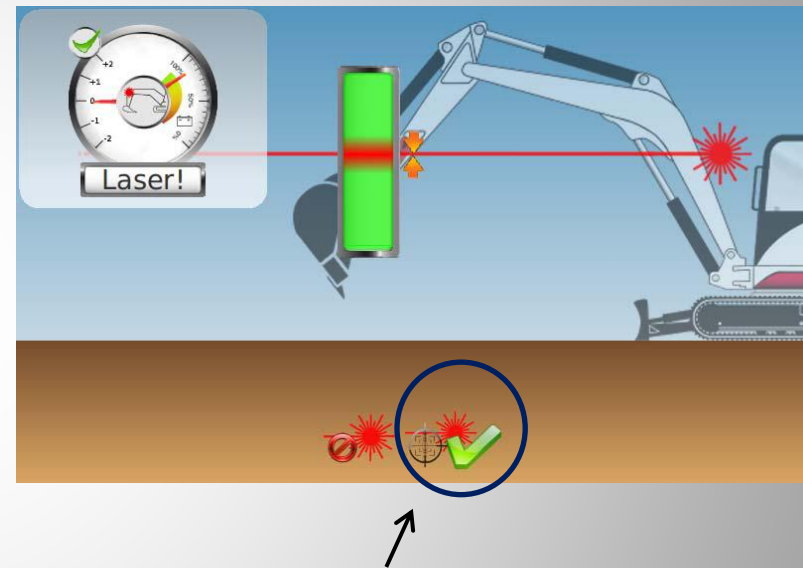

- Catch again the laser beam
- The machine move got compensated



Notes : 1D mode and 2D mode

In 1D mode, the measures are good for a single cabin position. This mode is suitable for the realization of single slope trenches. The measures are relevant ONLY in the axis of the trench. Any rotation of the cabin may cause an error, depending on the inclination of the excavator.

When level (horizontal) areas are made, the error caused by the rotation of the cabin may be easily removed by using an additional sensor installed on the chassis.

In 2D mode, a triple sensor measures the complete direction of the cabin, allowing total freedom of movement of the cabin. In this mode, the system allows to work on areas with dual slope.

Combined with a tilt bucket sensor, the system helps the user to adopt the ideal angle of the bucket in relation to the desired slope.

For large areas, each change of location of the machine may be compensated using the dipper stick sensor: It has a laser receiver inbuilt and after each laser catch the previous height change of the machine's body gets compensated.